

Building Physics Tools:

Needs, Use and the Lack of Use in the Building Process. Modelling Non-Isothermal Moisture Flow and Frost Penetration

Stephen Burke

Report TVBH-1017 Lund 2009
Building Physics LTH



LUND
UNIVERSITY

Building Physics Tools:

**Needs, Use and the Lack of Use in the
Building Process. Modelling Non-Isothermal
Moisture Flow and Frost Penetration**

Stephen Burke

Doctoral Thesis

Building Physics LTH
Lund University
Box 118
S-221 00 Lund
Sweden

ISRN LUTVDG/TVBH--09/1017--SE(215)
ISSN 0349-4950
ISBN 978-91-88722-39-3
©2009 Stephen Burke

To Gunilla, Maya and Arvid.

*Experience is that marvellous thing that enables
you to recognize a mistake when you make it again.*

Franklin P. Jones

*Experience is not what happens to a man;
it is what a man does with what happens to him.*

Aldous Huxley, "*Texts and Pretexts*", 1932

Preface

Over the course of the 7½ years that I have been a PhD student at Lund, I have met and gotten to know quite a few people within the building sector and most of you have contributed to this work in some way or another.

First I would like to go back in time before Sweden and thank Gunilla for having the courage to ask for a drive to the hockey game. She is also guilty of convincing me to apply for this position despite my arguments that building physics had nothing in common with environmental science. (In which I was completely wrong about!). Without her, none of this would have happened.

I would like to thank my supervisors Prof. Jesper Arfvidsson and Prof. Johan Claesson for all the support and help during my time in Lund. This thesis would not be nearly as good without your help, support and feedback.

Next I would like to thank FORMAS for providing financial support for this project.

Competitive Building was a very good experience. Through that program I have made a number of friends around Sweden from Luleå to Lund. It was a lot of fun touring around Asia and North America with you all. Some of the things I will not soon forget: ‘Professor Brian’ in Japan, Fredrik Anheim on the Japanese subway system, Fredrik Malmberg trying to convince us to get a receipt from a black cab, Ulf’s piano playing outperforming the hotel’s band, Lars Sunding’s hunt for the Fender, Dennis and Roine always watching the weather channel, and the night a bunch of us went drinking at the Jazz bar. I will never forget all the fun we had.

Work would be pretty dull without some of my current and past colleagues. Dennis has always provided the craziest ideas based on some kind of scientific fact and Delphi code; Anders Almgren, the craziest solutions to problems! Thanks to Johan Stein for all the interesting discussions and random bits of information that are usually useful. Thanks to Hans for the help with energy issues. It was also a blast measuring apartments with you at Bo01, even if the results can be a little depressing at times! Thanks to Olof for keeping me on my toes... always plotting on how he can trick me. I also must thank Lars-Erik and Dan for all their interesting discussions and help dealing with moisture and teaching problems. They are always there and willing to answer my questions! Thanks to Agneta and Kaisa for all of the help in the lab. Kaisa is one of the happiest people I know! Thanks to Lilian for all the help with the figures and

layout. It means the difference between excel figures and professional looking figures! Thanks to Petter for showing me how bad Vista really is (or the Lamborghini, not sure which one is the problem)!

Of course I need to say thanks to Building Services, Mats, Birgitta, Lars and Catarina for all the support you have given, from help with VIP+, to help setting up my PID controller! Another thanks goes to Building Materials for their equipment and expertise. Without help from Lars Wadsö, Stefan Backe and Bengt Nilsson I would probably have not succeeded in getting many measurements. Thanks to Thord Lundgren at the Department of Structural Mechanics for building the electronics for the non-isothermal moisture transport prototype.

A big thank you goes to Birgitta Salmi. I think I ask her a question everyday regarding administration issues. If it wasn't for her, I am sure I would have been given the boot a long time ago for not sending in some important form!

Finally I would like to thank my family and friends outside of work for all the support and encouragement. They remind me of why buildings need to be as good as we can build them.

Stephen Burke

2009

Lund.

List of Publications

Appended Papers

This thesis consists of the following appended papers:

- I. Burke, S. (2003). Reducing the Risk of Failure in Performance within Buildings. In ed. Atkin, B., Borgbrant, J., & Josephson, P-E., *Construction Process Improvement*, Oxford: Blackwell Science
- II. Burke, S., Johansson, D. & Öberg, M. (2002) Decreasing a Buildings Operational Energy Costs through the Application of Building Physics Principles During the Design Phase. *Sustainable Building Conference*. Oslo, Norway.
- III. Burke, S. (2003) The renovation costs of crawlspaces due to moisture damage. IN HANSSON, B. & LANDIN, A. (Eds.) *Construction Economics and Organisation - Proceedings of the 3rd Nordic Conference on Construction Economics and Organization*. Lund, Sweden, Division of Construction Management.
- IV. Burke, S. (2007). Crawl spaces in wood framed single family dwellings in Sweden: unwanted yet popular. *Structural Survey* 25(1), p. 51-60
- V. Wihlborg, C. & Burke, S. (2006) Decreasing the risk of moisture damage to prefabricated building components - from production to construction. *Research in Building Physics and Building Engineering*. Montreal, Canada, Taylor & Francis Group.
- VI. Burke, S. & Yverås, V. (2004). A Swedish Perspective on the Prevention of Moisture Problems During the Building's Design Phase, *Nordic Journal of Surveying and Real Estate Research* 1(1), p. 102-113
- VII. Burke, S. (2009) Confident or cautious moisture consultant – which is best, Submitted to: *Building Research and Information* on September 7th, 2008
- VIII. Burke, S., Arfvidsson, J., Claesson, J., (2009) A New Algorithm to Calculate Frost Penetration under a Building during Periodic Variable Conditions, To be submitted to: *Journal of Building Physics* after editing

- IX. Burke, S., Claesson, J. & Arfvidsson, J. (2008) A New Method of Determining Moisture Flow Coefficients for both Isothermal and Non-isothermal Conditions. IN RODE, C. (Ed. *Proceedings of the 8th Symposium for Building Physics in the Nordic Countries*. Kgs. Lyngby, Denmark, Dept. of Civil Engineering, Technical University of Denmark.

Other Publications

In addition to the previously listed publications, the author has also written or contributed to the following papers during the course of this research project which have had an influence on the direction in which the research has proceeded.

- O.P. I. Burke, S. (2005) Advantages and risks associated with crawl space foundations. *The 7th symposium on Building Physics in the Nordic Countries*. Iceland, The Icelandic Building Research Institute.
- O.P. II. Burke, S. (2003) Determining the Economic Effects of using Building Physics tools during the Building Process, Licentiate Thesis, Lund, Building Physics, Lund University.
- O.P. III. Burke, S. (2006) Stor risk för fuktskador i fel sorts krypgrund. *Husbyggaren*. Organ för SBR - Svenska Byggingenjörers Riksförbund.
- O.P. IV. Burke, S., Johansson, D. & Åberg, M. (2002) Examination of operational energy use and physical function utilizing building physics tools, in *Energi- och resurshushållning i bebyggelse*. Lund, Building Physics, Lund University.
- O.P. V. Arfvidsson, J., Bagge, H., Burke, S., Harderup, L.-E. & Lindström, L. (2005) Tätskikt i våtrum - Förstudien avser: Sverige, Norge, Danmark, Finland, Tyskland, Frankrike, Storbritannien, USA, samt Kanada. Lund, Avdelning för Byggnadsfysik.
- O.P. VI. Arfvidsson, J., Burke, S. & Elmroth, A. (2003) Statistik över fukt- och mögelskador i byggnader. Lund, Avdelning för Byggnadsfysik.
- O.P. VII. Bagge, H., Burke, S., Johansson, D., Kjellsson, E., Lindström, L., Olander, S. & Svennberg, K. (2004) Analys inför ombyggnad av

flerbostadshus i Växjö, in Byggnads- och installationsteknikens utveckling under 1900-talet. Lund, Building Physics, Lund University.

O.P. VIII. Gilkinson, N., Persson, M., Ruikar, K., Bagge, H., Burke, S. & Henrich, G. (2006) An International Comparative Study Considering Site Production for Sustainable Construction. *Construction in the XXI Century: Local and global challenges*. Rome, Italy.

O.P. IX. Norman Gilkinson, Kirti Ruikar, Bagge, H., Persson, M., Henrich, G., and Burke, S., (2006), Comparative Study of Swedish and U.K. Construction Production at Site Level Considering Communication and People Coactions, *Proceedings of the 3rd International SCRI Symposium*, Delft, Netherlands, 3-4 April 2006

Sammanfattning

Trots utvecklingen inom materialvetenskap, datorkapacitet och byggnadsteknik, fortsätter fel relaterade till byggnadsfysik att inträffa i våra byggnader. Dessa byggnadsfel spänner mellan att byggnader inte möter kraven på energianvändning till att byggnader orsakar hälsoproblem hos de människor som vistas i byggnaden till följd av att de utsätts för kemikalier eller biologiska organismer. Dessa fel orsakar samhället ansemliga kostnader varje år och en stor del av felen skulle kunna förhindras redan under projekteringen då byggnadens utförande och konstruktion bestäms.

Denna avhandling belyser några av de kostnader som är relaterade till fel som går att härleda till fuktproblem i byggnader och analyserar orsakerna till att dessa fel fortsätter att inträffa inom byggindustrin, trots att kunskap finns för att förhindra dem. Detta har gjorts genom att samla kostnader för fel i skadearkiv, studera användningen av datorbaserade verktyg, utföra intervjuer av fuktexperter och analysera hur konsulter arbetar och vilka begränsningar både de, och verktygen de använder, har.

Bland annat visas i avhandlingen att ansemliga summor pengar används till reparationer av fuktskador i byggnader. Ett annat resultat är att konsulterna som skulle kunna förhindra dessa problem att uppstå inte har möjligheterna till erfarenhetsåterföring på grund av bristfälliga ledningsstrukturer och en organisation som fokuserar på egen ekonomisk vinning och inte tillräckligt på vidareutbildning av konsulterna. De byggnadsfysikaliska verktyg som finns används inte på grund av att de är dyra, har dålig användarvänlighet eller att det finns brister i informationen avseende nyttan med verktygen. Avhandlingen föreslår en organisatorisk modell som kan göra erfarenhetsåterföring attraktiv för konsulter.

Många av de existerande byggnadsfysikaliska verktygen lider dessutom av begränsningar till följd av att man har använt för stora förenklingar i fukttransportteorin genom att man inte tar hänsyn till ickeisoterm fukttransport eller varierande termiska egenskaper. Avhandlingen diskuterar några av problemen med modeller för ickeisoterm fukttransport och föreslår förbättringar av dessa modeller.

Abstract

Despite advances in material science, computers and building technology, building failures related to building physics continue to occur. These failures range from a building not meeting its energy use target to a building causing people to become ill from exposure to various chemicals or biological organisms. These failures cost society considerable amounts of money each year and many of these failures are preventable already during the design stage of the building process.

This thesis looks at some of the costs associated with building failures due to moisture problems and explores the reasons why these failures are persistent in the building industry. This is done by looking at the role of computer based tools, interviewing moisture consultants, analysing how they operate and what limitations both they, and the tools they use, have.

One result in this thesis shows that a considerable amount of money is spent on repairing moisture damages in buildings. Another result is that the consultants who can prevent these problems are not able to accumulate experience due to a poor management system which only focuses on profit and not the development of the consultants. Building physics tools are not used due to high costs, usability issues or inadequate information regarding the use of the tool. A system of operation is proposed in the thesis which can make experience meaningful to consultants.

The tools themselves are limited by deficiencies in moisture transport theory which cannot take into account non-isothermal moisture transport or variable thermal properties. Some of the problems with non-isothermal moisture models are discussed and new ways to improve such models are proposed in this thesis.

Keywords: building physics tools, costs, moisture damages, learning loop, causal loop diagrams, experience, isothermal, non-isothermal, moisture transport

PREFACE III

LIST OF PUBLICATIONS V

 APPENDED PAPERS V

 OTHER PUBLICATIONS..... VI

ABSTRACTIX

1 INTRODUCTION - 1 -

 1.1 AIM AND OBJECTIVES - 2 -

 1.2 READING GUIDE AND APPENDED PAPERS..... - 2 -

 1.3 CONNECTIONS BETWEEN THE PAPERS - 3 -

 1.4 LIMITATIONS - 6 -

2 THE USAGE OF BUILDING PHYSICS TOOLS DURING THE BUILDING PROCESS..... - 7 -

 2.1 STATE OF THE ART - 7 -

 2.1.1 *Heat*..... - 7 -

 2.1.2 *Air* - 9 -

 2.1.3 *Moisture*..... - 10 -

 2.1.4 *Usage of Building Physics Tools in Industry*..... - 11 -

 2.2 METHODS - 12 -

 2.2.1 *Literature Review*..... - 12 -

 2.2.2 *Case Study - Svedala*..... - 13 -

 2.2.3 *Interviews*..... - 13 -

 2.2.4 *Archives* - 15 -

 2.2.5 *Systems Analysis* - 15 -

2.3	RESULTS AND DISCUSSION.....	- 16 -
2.3.1	<i>Example of Costs Attributed to Poor Designs</i>	- 16 -
2.3.2	<i>Why are current tools not used?</i>	- 19 -
2.3.3	<i>Confidence and level of awareness</i>	- 21 -
2.3.4	<i>Lack of knowledge and experience</i>	- 23 -
3	FROST PENETRATION MODEL.....	- 33 -
3.1	STATE OF THE ART	- 33 -
3.2	METHOD	- 34 -
3.3	RESULTS	- 35 -
4	MOISTURE TRANSPORT MODEL	- 37 -
4.1	STATE OF THE ART	- 37 -
4.2	ISOTHERMAL MOISTURE TRANSPORT	- 38 -
4.2.1	<i>Isothermal Measurements</i>	- 38 -
4.2.2	<i>Results from Isothermal Measurements</i>	- 42 -
4.2.3	<i>Preliminary evaluation of Isothermal Measurements</i>	- 45 -
4.3	NON-ISOTHERMAL MOISTURE TRANSPORT	- 50 -
4.3.1	<i>Non-Isothermal Moisture Transport Measurements</i>	- 51 -
4.3.2	<i>Results of Measurements with the Prototype</i>	- 55 -
4.3.3	<i>Proposed Evaluation of Non-Isothermal Measurements</i>	- 56 -
5	DISCUSSION AND CONCLUSION	- 59 -
6	REFERENCES.....	- 65 -
7	APPENDIX I – APPENDED PAPERS	- 75 -

7.1	PAPER I.....	- 77 -
7.2	PAPER II.....	- 89 -
7.3	PAPER III.....	- 97 -
7.4	PAPER IV.....	- 105 -
7.5	PAPER V.....	- 117 -
7.6	PAPER VI.....	- 125 -
7.7	PAPER VII.....	- 139 -
7.8	PAPER VIII.....	- 157 -
7.9	PAPER IX.....	- 169 -
8	APPENDIX II – INTERVIEW QUESTIONS.....	- 179 -
9	APPENDIX III – MEASURED RESULTS.....	- 183 -

1 Introduction

Building failures related to moisture, ventilation and energy issues could be avoided if there were fewer misunderstandings and more knowledge between the different actors involved in the building process over the importance of building physics. Ignoring building physics principles during the design and construction phases can lead to a number of problems during the operation phase such high energy usage, health problems, physical building damage and a host of other problems related to these (Wardhana & Hadipriono 2003). These problems are mirrored in the amount of mass-media attention that problematic buildings are receiving; even to the point of being scandalous to the companies involved in all phases of the project (Jelvefors 2002; Luthander 2001).

Companies and clients spend huge amounts of money each year to rectify these problems (Josephson & Hammarlund 1999). For example in 2001, Canada's national housing corporation reported that premature building failures (all types) cost Canadian's about \$225 to \$375 million CDN annually .

A recent moisture related problem in Sweden was a single stage, concrete rendered façade on a wood framed wall. A similar type of wall was used in Vancouver, Canada in high rise condominiums. The latest estimate is that the repair costs will exceed \$ 2 billion CDN just for Vancouver (Lazaruk 2006). Both issues revolve around the same problem, that moisture can enter the wall through small cracks in the concrete rendering, typically around windows and doors, and becomes trapped in the construction (Barrett, D 1998; Jansson, Samuelson & Mjörnell 2007; Samuelson, Mjörnell & Jansson 2007). It is estimated that this type of wall will also be the cause of billions of Swedish Kronor in damages within the Swedish building stock (Brinck 2007; Larsson 2008; Sandén 2007).

Problems of this nature are difficult to predict because in theory the constructions work. In practise they fail because of small errors in workmanship or poor material selection. In other words they are very unforgiving if not constructed perfectly.

A number of moisture related problems should easily be avoided through the use of current building physics based tools. Unfortunately there are a number of reasons why they are not widely used. One problem has to do with the engineering companies not willing to pay for their employee's to learn the

available tools. Another is that the tools can be difficult to learn despite being simplified. Finally, there are problems related to a lack of, or too simple tools. For example, most real problems involve a broad temperature and moisture range, both of which are dynamic and can even include freezing conditions. Most tools are based on data measured at 20°C for a few humidity levels. In addition, current moisture transport theory based on Fick's Law (which is the theory used in moisture simulation tools) is not able to completely describe moisture flow in all materials, for example as in wood.

1.1 Aim and objectives

This study will help the building industry avoid making the same mistakes in regards to moisture and thermal performance by showing:

1. why building physics should be taken into account during the design and construction process
2. the role that building physics tools play during the design phase
3. a systematic weakness in the moisture consultant's method of operation which can render level of education and traditional experience as we know it meaningless for the individual in focus
4. some weaknesses with current building physics tools and models, specifically non-isothermal moisture transport models and temperature simulation models, upon which almost all current tools are based

1.2 Reading Guide and Appended Papers

This thesis consists of nine papers with the common theme of Building Physics based tools. Some of these have been a part of the Licentiate Thesis I completed in 2003. This summary of the compilation thesis will present an overview of the nine papers and how they are connected.

The most essential papers for the building industry in this thesis are Papers VI and VII which provide insight into why the building industry makes the same mistakes over and over again. They can also explain why new building physics theory, in particular moisture theory, is not widely implemented until required by law. All the papers previous to these in the list have contributed to these two beginning with a look at the economical effects of building physics tools during the building process.

The next section describes the appended papers, describes how the papers are connected under the theme of building physics tools in the building industry and informs the reader of what role I had in each paper. The reader can then choose if they would prefer to read the summary, which is an overview of what is written in the articles, or the collection of papers attached in the Appendix, which goes into more details.

1.3 Connections between the Papers

This section describes how the papers are connected under the theme of building physics tools in the building industry and informs the reader of what role I had in each paper. This project began looking at the economic aspects of these tools in the building industry. It evolved into looking at how consultants in the building industry operate and how this system does not prevent mistakes from being repeated in the future, even with the best tools.

Paper I introduces this project by defining what is meant by building physics in Sweden. It also looks at some of the internationally available information showing economic costs which can be attributed to building physics related failures. Common computer based tools are introduced as a means of reducing the risk of building physical failures in buildings.

Paper II looked at what economical effects could be gained by using building physics to decrease the energy use of an existing building. An extended version of this paper is Other Publications (OP) IV which is also available in the Licentiate thesis, OP II. Most of the work was done by all three authors together. This included writing and final editing of the article, the calculations using computer software and measuring in the apartments. During the course of this work, it became obvious that there is a lot of effort going into reducing the energy use of buildings. However, an energy efficient building does not mean that it has a good indoor environment or that it is free from moisture problems.

The next step in the project was to decide what specific economic effects should be looked at. Energy was a very popular topic with a lot of information available, however moisture damage in buildings is one cause of structural problems in buildings as well as a significant factor determining the indoor air quality and hence have the most potential savings. A study was done as a Pre-Study for Boverket (The National Board of Housing, Building and Planning) in Sweden (Dnr 100-2786/2002) (published in OPII) to see what kind of moisture damage information was available for researchers in Sweden. It was

determined that most building companies did not have such information. Most consulting companies did not have this information either and almost all companies who had this type of information were not willing to let it to be used in research. One source, the National Organisation for Aid to Owners of Private Small Houses (SSN), did have extensive information on moisture damages specifically focused on outdoor ventilated crawlspace foundations. It was decided to use a collection of data from SSN which was already available at the section for Building Physics at the Department for Building and Environmental Technology at Lund University. Paper III presents the results of the information found in the SSN archives. It was concluded that there are significant costs associated with the repairs of outdoor ventilated crawlspace foundations. These costs should be unnecessary for the home owner because the origin can be considered to be the result of a poorly designed house. This lack of economical data within Sweden, together with the fact that a cheap means of preventing moisture damages in buildings is to not make the same mistake twice, lead to an increased focus on the role of the consultant still from the perspective of the building physics tools.

Paper IV was based on OP I, which was written for the Building Physics in the Northern Countries Symposium in Iceland. The article presented different types of crawlspace foundations and discussed the advantages and disadvantages of each. The papers also point out that experts have been in agreement for about 20 years that there is no risk-free way to build an outdoor ventilated crawlspace foundation. However, the building industry did not pay attention to this and even today still continues to build these world-wide even though there are at least two other types of crawlspace foundations which work better with less risk for moisture damage. The question brought up from the ensuing discussion at the conference was how effective is our teaching and information dissemination? Why does the building industry keep using techniques that are known to fail?

Paper V was based on an interesting problem regarding moisture problems that developed in prefabricated modules before delivery. In this paper, I was mostly involved in the literature review, writing some of the sections and editing the final version of the paper. All measurements and site visits were done by Wihlborg. In recent years a lot of effort has been put into prefabricated construction, or the fabrication of a building's components indoors. The advantages put forth by the marketers of these buildings include less risk for moisture damages and a more consistent quality since the components are constructed in a controlled indoor environment. This paper showed that a poor understanding of moisture problems can even cause

problems in a controlled climate. It also showed that moisture problems can be systematic and can occur at any time, in this case during the storage of the completed constructions. Ironically, the problem occurred because the modules were built in a warm indoor climate and then sealed and stored outdoors in a cold climate. With no ventilation in each module, the moisture in the air quickly condensed and allowed mould to grow on much of the organic surfaces within the modules.

Interviews were conducted to find out more regarding the use of building physics tools in the industry. The result of these interviews is Paper VI. In this paper, all work was done by both authors working together, even editing the final version. It was quickly realised that the reasons that tools were not used in Sweden corresponded to work done by other international researchers who have given similar surveys. However, there was an interesting observation that indicated that there were no relationships between years of experience and ability for the consultants interviewed in regards to moisture problems. More disturbing was that there appeared to be a parabolic relationship (see Figure 4, section 2.3.3) between their level of education and their confidence level in dealing with moisture problems. In other words, it appeared that the consultants least qualified to work with moisture problems were the people whom appeared to be the most confident that their solutions solved problems that are still not solved by researchers.

In Paper VII, the focus became the question of what system does the consultants work under that would cause experience to be so meaningless? Using Systems Analysis in combination with numerous discussions with various people within the consulting sector and academic world, a system was developed which answered a number of questions. It became apparent that consultants do not get feedback on their work since they are always driven to get new contracts. Without this feedback they never learn what solutions worked and what failed. Further work by Yverås (2009) reinforced this observation.

In the interviews, the consultants stated that more tools are needed that are accurate and cheap. Paper VIII involves the simplification of an advanced building physics tool, JAM, by developing one tool that simulates the frost penetration under a foundation. Most tools which calculate or simulate thermal and moisture problems use many simplifications. One is that the material's description and theory is valid for isothermal measurements. This paper shows how having a variable thermal conductivity of soil, based on the temperature of the soil, can change the results of the simulation significantly. In this article,

I built the computer program around Arfvidsson's calculation engine, ran the simulations and wrote most of the article. Claesson helped with the theoretical model and the editing of the final version.

Paper IX begins applying this idea for moisture problems. In this paper, I designed, built and ran the experimental method. I also wrote most of the article getting assistance with the theoretical parts and ideas from the co-authors. Since we lack data on what effect a temperature gradient has on the moisture flow in wood, it describes a new method of measuring the effect of temperature on the moisture flow in wood. The preliminary results from these measurements show that the method works. However the details must be improved to make the method more reliable. This kind of work is needed in order to develop better non-isothermal models.

1.4 Limitations

Limitations are taken up in the articles and directly in the text in the various sections.

2 The Usage of Building Physics Tools During the Building Process

This Chapter is based on Papers I-VII.

2.1 State of the Art

Building physics is the science of how energy interacts with the materials within a building envelope. It encompasses the fields of heat transfer, moisture transfer and air flows. This means that building physics can include other areas such as energy efficiency, indoor air quality, mould in buildings, ventilation systems etc. As seen in Figure 1, some countries include acoustics and fire protection; however in this report the Swedish definition is used. For a more detailed description of the various topics below, please refer to Paper I.

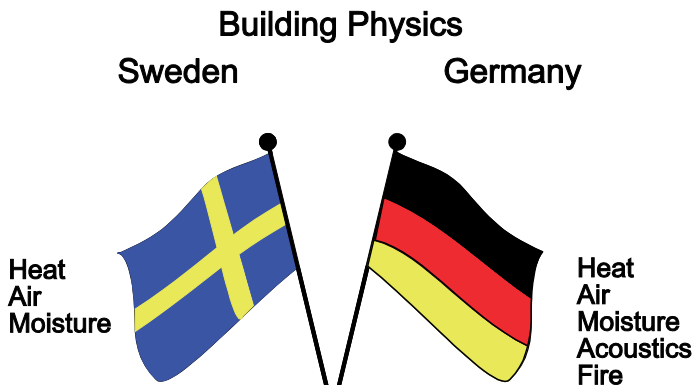

Figure 1: Building physics in Sweden is defined differently than in other countries, for example Germany includes acoustics and fire studies in their definition of building physics and Sweden does not.

2.1.1 Heat

One of the aspects that building physics covers is the study of heat transfer through a building's envelope. Energy efficient buildings might not be as prevalent as they are today if it were not for this area of science. The idea with energy efficient homes is to reduce the amount of energy needed to operate the building. Achieving this is done by increasing the amount of insulation within the walls, tightening the building envelope and optimising the ventilation system so that less energy is required to maintain a constant temperature inside

the building. This idea applies for both warm and cool climates. This increases the level of comfort in the building since people are very sensitive to even small changes in temperature. A poorly insulated building can be an uncomfortable building (Öberg 2002). However, thermal comfort is not only determined by temperature differences; for example moisture levels, air pressures, air movement and material choices are other factors that play a role with the thermal comfort of the indoor environment (Fang et al. 2004).

Currently in Sweden, energy use in the building sector accounts for almost 40% of the total energy used (Kåberger & Hammes 2008). The majority of this is related to the operational phase of a building's life. The interest in energy conservation during all phases of a construction project have stemmed from the implications regarding the environment and economics.

Unfortunately, energy efficient buildings have negative aspects that are not so clear-cut. Since the walls must be thickened and tightened, this can cause problems in the areas of ventilation and moisture control. If a building is not designed properly, the risk for moisture and ventilation problems increases as the energy efficiency increases (Thörn 1999). The building also becomes more sensitive for what were considered smaller issues and it becomes very important to treat all three variables - heat, air and moisture, at the same time. For example, in modern Swedish and energy efficient homes the building envelope is almost airtight to minimise heat loss via escaping airflows, windows are upgraded and the insulation is thickened. Thermal bridging that is considered negligible in an older house can provide a means of significant heat loss and even moisture problems in an energy efficient home. The ventilation system becomes vital to control the indoor air quality and indoor moisture levels. Only an understanding of heat, air and moisture transfer theories along with knowledge of the material properties in the construction can counter these effects.

Calculating the temperatures of different layers in a wall is straightforward today using modern computer software. Increasingly, researchers and industry are combining thermal calculations with moisture calculations since the two are linked. The theories behind these calculations are essentially the same. However there is one small factor that increases the difficulty of calculating the moisture levels; the moisture properties of materials are very sensitive to changes in the moisture and temperature state. When calculating temperatures, one assumes constant moisture content. One cannot assume a constant temperature when dealing with moisture flows. In addition, there are other

variables such as the material's properties and air velocity that can have effects on the flows.

Computer software is readily available for calculating heat flows in buildings and even moisture flows through materials (See 2.1.4). However almost all of the moisture simulation tools make some assumptions which may affect their accuracy (see Chapter 4 on non-isothermal moisture transport).

Most of the available tools are designed to calculate the heat flow through various components which make up the attics, walls, and crawlspaces. They can simulate the heat flow in a one, two, three and four-dimensional states. The refining of these types of programs has led to software that is specialized to calculate energy loss. These programs can be very complex and can take into account the position of the building (to calculate solar gains or the amount of shading from other buildings or trees), the types of materials used, the type of ventilation system, the amount and type of heating required, the physical dimensions of the building, the effect of the local climate on the energy usage, etc.

2.1.2 Air

Ventilation, whether it is natural or mechanical, provides air from the outdoors into buildings. Poor ventilation can lead to indoor air quality problems that can, in turn, lead to health problems (Hägerhed-Engman 2006; Seppänen & Fisk 2002). Poorly designed ventilation systems can also be energy intensive and give a poor indoor environment. If the ventilation system is not balanced properly, condensation can occur on the windows, in the walls due to leaks in the building envelope, and odours can be detected from neighbouring apartments. This can also lead to other problems like mould growth and high dust levels.

If these problems continue without remediation, health problems such as allergies, itchy skin and eye irritation may surface in the occupants of the building. These symptoms are more commonly referred to as Sick Building Syndrome (SBS). Asthma is one of the serious problems, which in the US, seems to be increasing despite the fact that ambient air pollution is decreasing. (Brugge et al. 2003)

Engdahl (1998) showed that these problems are more prevalent than one may believe. In his study, it was found that, on average, only about 33% of all multi-family buildings, schools and offices in Sweden conformed to the

regulations regarding airflows that were valid when the system was brought into operation. In other words, 67% of these buildings were not up to the standards of when they were installed.

2.1.3 Moisture

Moisture problems are one of the main topics today in building physics. It is a complex problem requiring a holistic approach in order to grasp the true effects of this problem. To gain an appreciation of the scope of the problems generated by excess moisture in a building, we must look to medical doctors, researchers, microbiologists, environmental scientists, biologists, physicists, chemists and engineers for their input and experiences.

Moisture can occur in a building through a number of different paths. There are three methods of transportation that allow the water to come into contact with the materials, convection, diffusion and capillary action. Convection occurs when air moves the water particles. Diffusion is the phenomena of where the water concentration wants to be at equilibrium. Capillary action mostly occurs underground where the water travels into materials with small pore spaces.

Whichever method the water takes, there is a risk during the entire construction process that materials will become wet. Before the physical construction work begins, materials can be delivered wet. They can become wet after delivery because of improper storage, storage on the ground or exposure to the climate during construction. It is important to protect the materials during every phase of construction. Wet materials during the construction phase can lead to problems later (Samuelson & Nielsen 2002).

After the building is finished, it is still at risk from both the indoor and outdoor environments. There is an increased risk for moisture problems to occur once the moisture level of the environment reaches 75%. Ventilation control becomes even more important in removing excess moisture in the air, moisture that is attributed to building materials, people sweating, showering, cooking foods, etc. Some industries and recreational facilities must also deal with high moisture levels by having adequate ventilation systems. These include paper mills, swimming halls, and other facilities that have a large quantity of open water (Ebbehøj et al. 2002).

2.1.4 Usage of Building Physics Tools in Industry

According to various studies (Arfvidsson & Sikander 2002; Augenbroe 2002; Boyer et al. 1998; Ellis & Mathews 2001; Hien, Pho & Feriadi 2000), it appeared that designers of buildings did not use the tools that were available because of a number of reasons. Ease of use, or usability, was a significant factor, i.e. the tools that were available were too complex or not user friendly and were time consuming to use. These tools can also require a high level of knowledge to both input the required data and interpret the results. In addition, some of the initial data required to run the simulations may not be decided upon until well into the project and can lead to problems with the initial input data.

Boyer et al. (1998) points out that researchers are the ones responsible for the construction of these tools for the designers and policy makers. The authors also state that the models should be a simplification of reality that uses recent theories that are adequately supported by the scientific community. Unfortunately what the researcher thinks of as simple, the other groups may find redundant hence leading to the problems above that discourage the use of these tools.

Augenbroe (2002) has a similar point of view regarding the difficulty of using current tools, however argues that experts should make programs that run over the Internet for other experts. This is because the current trend “recognizes that the irreplaceable knowledge of domain experts and their advanced tool sets is very hard to match by ‘in-house’ use of ‘dumbed down’ designer friendly variants” (Augenbroe 2002). In other words, the industry should employ experts that are able to run and understand the latest programs and theories. Hien et al. (2000) agrees with this stating, “...such software [software that analyses acoustics, ventilation and indoor air quality] should only be used by the specialists”.

Bellia (2003) contradicts this by stating, “that the application of more complex calculation methods, in most cases, should result impracticable, especially by design professionals”. In other words, tools should be made for the typical designers, not for a few specialists.

With the introduction of the Energy Certification of Buildings within Europe (Cox & Boel 2002), and the increasing cost of energy, more tools and knowledge will be in demand in the near future. Building physics is the core science which can realise energy use reduction in buildings. Future tools must

take into account all aspects of building physics or there is a risk that energy savings will come at the cost of moisture control, resulting in a situation similar to the 1970's where buildings suffered extensive moisture damages due to incorrectly installed thermal insulation, moisture barriers and too low airflows in the ventilation system (Arfvidsson, Hagentoft & Samuelson 2005). Already in Sweden, Bagge (2007) shows examples of what can happen to the energy use of a building when an energy simulation tool is used incorrectly by engineers. They can be off by as much as 300%! This reinforces Augenbroe (2002) and Hien et al. (2000) by showing that it is very important that the simulation operator be correctly trained and educated to use the specific tool and know what the limitations of the software are.

2.2 Methods

A number of different research methods have been applied related to this chapter. This section describes all of these methods. Section 1.3 describes how these methods are connected.

2.2.1 Literature Review

The first method used is the literature study (initial results in Paper I). The literature study was performed to answer the following questions:

- What aspect of building physics should be focused on in respect to the economic questions?
- What is potentially the most expensive failure that can be solved using building physics?
- Can this failure be studied within the specified time period?
- What are the alternative failures that can be studied?
- Has there been any work done previously relating economic issues to building physics aspects? Where? What were the results of the study?
- What tools are available to industry today? What are the properties of these tools? Does industry use these tools? Why or why not?

2.2.2 Case Study - Svedala

Paper II (a short version of OP IV which was formatted for the Sustainable Building Conference in Oslo, Norway) used a case study in order to determine if current software could improve the design with minimal affect to the cost. A dwelling in Svedala was selected as the case study. This project had economic studies done in the past (Persson, M. 1999) and was praised for its high quality for low cost.

Drawings were acquired in order to study the technical details of the building from a building physics standpoint. Field tests consisted of temperature measurements using an infrared spot thermometer, temperature profiling using a thermal imaging system, and air leakage tests using air pressurization and depressurization. Of particular interest were the thermal bridges, the air infiltration and ventilation rates. In every calculation and simulation, the real indoor and outdoor temperatures were used.

Energy use data (heating and hot water energy) and climate data for the previous year were obtained and the drawings were analysed using VIP+, ENORM, and HEAT2 (Blomberg 1996; Byggtjänst; VIP+ 1996). VIP+ and ENORM simulations were run using the same specifications as the buildings and this data was compared to the real values. HEAT2 simulations were compared to thermal images. Once the input data was entered into the simulation programs, a number of parameters were changed in order to determine the energy savings that could have occurred.

2.2.3 Interviews

Interviews with eight Engineering Consultants from various companies have been used during this project to answer some of the questions above that were not answerable using the literature studies (results in Paper VI). The interviews were designed around the following two themes using (Taylor & Bogdan 1998) as a guide:

- Their perception of the building process.
- Their level of comfort and experience in working with building physics issues.

The methods used in the design of the interviews were based on a combination of open and closed (yes, no, specific alternatives) questions (see Appendix II). The open questions were used for assessing key issues of the interviewees

unbeknownst to them. For example, a respondent can be assessed on his or her familiarity with the latest information and technology without directly asking. Closed questions were used to categorise the different interviewees into predetermined categories.

In total eight consultants were interviewed in a time span of two weeks. Only a couple of consultants declined to be interviewed because they were too busy but were positive to the interviews and some even recommended alternative people to call. The majority of the people approached accepted the request. All the consultants answered all of our questions to our satisfaction.

Table 1: Profiles of those interviewed

Category	Education	Experience
A	PhD in building physics	20 years
	Civil engineer + extra education building physics	15 years
B	Civil engineer	30 years
	Civil engineer	15 years
	Civil engineer	15 years
	Civil engineer	7 years
C	2-year engineering diploma	6 years
	High school	40 years

After the 5th or 6th interview, answers were being repeated, resulting in almost no new information. We decided after the eighth interview that it was not necessary to conduct any more interviews.

All interviews were recorded for further analysis and notes were taken during the interviews. The interviews ran from one to two hours depending on the respondent.

2.2.4 Archives

Paper III consisted of a review of archived documents from SSN located at the Department of Building Physics that were used in a previous study done by (Svensson 1999). Of the total archived documents, there was sufficient data to review 188 different cases from all over Sweden. The information consisted of applications made for funding for moisture-damaged homes with crawlspace foundations. This study involved looking at the cost to repair the home to a satisfactory state and this cost was based on the lowest bid submitted by various construction companies. This cost was compared to the age of the house and its market value in a repaired state i.e. the price that the owner could sell the house for after the repairs were completed.

2.2.5 Systems Analysis

Systems analysis refers to the science of understanding how systems function. One of the primary tools within systems analysis is a Causal Loop Diagram (CLD). A CLD is a standardized tool developed in the 1960's (Forrester 1961) that can be used to visualise an individual's understanding of a system. For a more detailed explanation see Paper VII. Its primary advantage lies in the fact that it allows people from different disciplines to communicate ideas in a standardized way in regards to how a system functions and how one component affects other components. Using this tool, a CLD was created showing the system in which engineering consultants operate within in the building industry based on the previous experience of the authors and interviewed consultants who work with moisture problems.

Knowledge management refers to a system of how an organisation captures and re-uses project knowledge. This incorporates well known learning theories and models such as the Plan-Do-Check-Act (PDCA) cycle (Deming 1986), which is used in ISO 9001, double-loop learning developed by Argyris et al. (1985) and experimental learning developed by Kolb (1984). Knowledge management and more information regarding the application of learning methods within the building industry can be found in Sunding (2006) and Persson (2006).

2.3 Results and Discussion

2.3.1 Example of Costs Attributed to Poor Designs

Unfortunately, many projects are built focusing on the construction costs, and not the Life Cycle Cost (LCC) (Johansson 2005). Often the lowest bid is the winner of the project. In order to reduce the costs as much as possible, cheap simple solutions are used without taking into account the operation costs over the building's lifetime. In Paper II, a simple example of how building physics can reduce operating costs over the lifetime of a building is presented. This was done by analysing different energy savings measures and factoring in the increased cost during the production phase and decreased cost during the operation phase of a building. It was shown that the most efficient energy savings measure (i.e. no increase in the LCC) would be to have a balanced ventilation system. This should have taken care of the occupant's complaints regarding poor indoor air quality and should have reduced the feeling of drafts by the occupants from the current air inlets located in the walls. Reducing the drafts should in turn reduce the indoor air temperature needed for the occupants to feel comfortable reducing the energy use for heating. In this study, it was also concluded that the tools used correlated well with measured values, however there were some slight errors, which were attributed to quality of workmanship.

Since the basic concepts in the area of building physics are usually ignored (Becker 1999), preventable failures are continuing to occur in modern buildings. The problem is that the industry is not easily convinced to change their methods and prefer to continue working in the same manor as before using 'tried and proven' constructions without thinking of the implications (Landin 2000) or seeking feedback on the used solutions. Paper III, shows that in Sweden, documented problem crawlspaces cost an average of about 163000 SEK (17400 €) to repair. This figure is very similar to a report published one year later by a company named Anticimex (2004) who used their own data as a base for their study.

Unfortunately the tried and proven methods are not always the best methods, particularly when new technology is used in combination with these methods. It is important to remember that each new building is essentially a prototype and what worked 100 years ago, may not work today. For example, a crawlspace worked very well in the past (OPs 1, and 3), however it has been modified into different variations, some of which do not function very well today because the combination of advances in material technology and the

particular design. Other variations function well, but are more costly and a full basement is a more cost effective solution. The reason for the failures associated with crawlspaces is that in the past, the crawlspace was a heated space due to the lack of insulation in the floors. Today's houses are much more energy efficient, with plenty of insulation under the floors yet the problematic crawlspaces are those still ventilated with outdoor air. This results in a low temperature and high level of humidity under the floor, which are ideal conditions for mould growth. This is thought to be one of the causes of SBS (Apte, Fisk & Daisey 2000; Wargocki et al. 2000; Willers et al. 1996). In addition to mould growth, the tightness of a building also seems to be a contributing factor to poor indoor air quality.

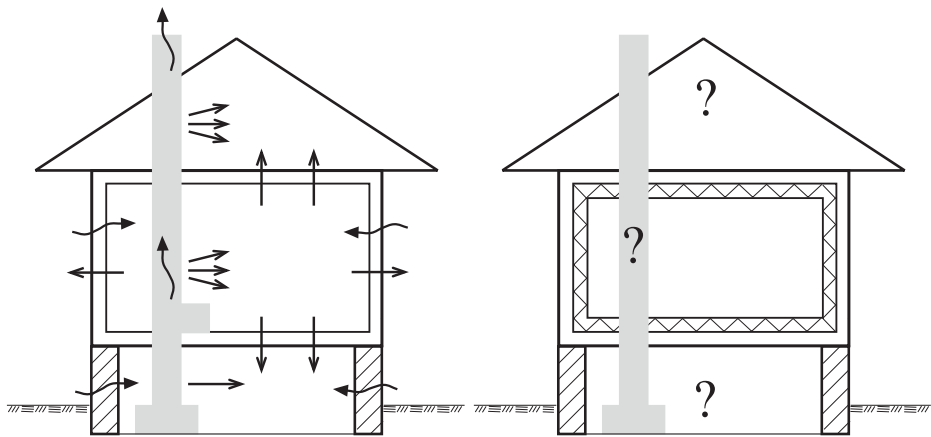

Figure 2: Heat (straight arrows) and airflows (wavy arrows) in an older house in comparison to a new house.

It is thought that buildings in the past did not cause SBS because the construction was so leaky that old buildings actually had very good ventilation. Figure 2 shows the difference between a past and a modern design. In the past, heat, air and moisture flowed quite freely between the various components. Heat from the fireplace and chimney warmed the main living area, the crawlspace and the attic. However there were not as many moisture sources. Now, buildings are well insulated in both the crawlspace and attic and are very tight. This means that there is very little to no heat, air and moisture flows through the building's envelope, to the crawlspace and attic. The result of less heat flow is that the surface temperatures in both the attic and crawlspace are reduced, increasing the RH at the surface of the material increasing the risk for mould growth.

Additionally, in a house with a poor ventilation system, the moisture that is released into the indoor air from cooking, bathing, washing, and people has no other way to escape the house and may diffuse and leak through the construction. The result is that the relative humidity can increase very quickly in the cold spaces causing condensation on the cooler surfaces. Ventilation systems help by extracting the moist air and replacing it with dry outdoor air. A negative pressure in the indoor environment caused by a ventilation system can help reduce the moisture flows into the attic and crawlspace but it will not solve the underlying problem of cold surfaces. If the ventilation system is not designed correctly or fails, the quality of the indoor air will quickly deteriorate. (Sundell 2000)

One method to help the industry take notice of particularly bad designs is to show that they are not economically viable to the customer. Over the long term, choosing one design over another can have the same end result as far as production cost, but one design can cost the owner much more money over the long-term perspective when looking at the LCC of the building. Unfortunately, there is only limited information available to customers regarding this topic, mostly within the ventilation industry (Industries 2001; Johansson 2002; Vik 2003).

In Canada, there is one specific type of moisture problem which is estimated to cost more than \$2 Billion CDN in direct reparation costs. These costs do not take into account possible health costs from a poor indoor air quality. It is referred to as the 'Leaky Condo' problem however it is a problem of moisture control and not water leakage. (Lazaruk 2006)

An explosion in the number of multifamily buildings occurred in the 1980's and 1990's. These were built to the minimum standard required by law in Vancouver, Canada using a single stage wood framed wall with concrete rendering applied to the insulation. The climate in Vancouver is very moist with driving rain coming from the Pacific Ocean. Thus, moisture became trapped within the exterior walls and caused the wood to rot leading to structural failures. Current solutions to this problem include using a two stage system (airspace in between the rendering and weather barrier) and water repellent weather barriers however there is still research being conducted into how to solve these moisture problems. (Barrett1998)

Another example of costs can be seen from a research project in Uttar Pradesh, a state in India which looked at the economic burden caused by respiratory illness. In this project the author looked at the direct costs, indirect costs and

costs of dealing with this illness. Poor indoor air quality due to the combustion of bio-fuels was suggested as one of the main causes and the total economic burden was found to be between 73 billion to 167 billion Rupees (€1.3 to 3 billion) per month (Parikh & Biswas 2002). In the US, the direct and indirect costs of treating asthma caused by poor indoor air quality were reported to be about \$13 billion US (€1 billion) (Weiss & Sullivan 2001). Fisk (2000) reports that the potential annual savings and productivity gains are; US\$6-14 billion (€ – 12 billion) from reduced respiratory disease; US\$2-4 billion (€1.7 – 3.4 billion) from reduced allergies and asthma; US\$10-30 billion (€3.4 – 25 billion) from reduced SBS; and US\$20-160 billion (€17 – 136 billion) from direct improvements in worker performance that are unrelated to health issues. In 2002, approximately 6,3% of Sweden's BNP, or SEK 147 Billion (€16 billion) were invested in the building sector (Byggindustrier 2003 pp. 6). Tolstoy (1994) states that in Sweden, roughly SEK 6 billion (€65 million) per year is spent on repairs and maintenance of buildings and of that, approximately half goes to damages attributed to moisture damage.

2.3.2 Why are current tools not used?

As mentioned in section 2.2.3, interviews were conducted with eight engineering consultants regarding moisture problems and tool use. More is found in Paper VI.

When asked what building physics tools were used when conducting the evaluation of a building, most replied that they did use some very basic ones. When asked about what programs would comprise a 'wish list', only the building physics expert had suggestions. The others said they did not know since either their local expert uses the tools, or they did not use any.

When those who replied that they did not use any tools were asked why, they replied that they were too costly to buy, too difficult to learn, required too much time to run the simulations, and not enough time was allocated to evaluate a building's design properly. These results follow Hien et al. (2000) who found that "Most firms view the use of simulation tools as involving extra costs and effort but with little recognition and appreciation from the clients."

According to the consultants, the most desired features of any tool were that they had to be easy to use in terms of low level of input and output data. These are statements that contradict with what is typically produced by researchers. Researchers have too often failed to deliver numerical models and tools that are user friendly and that take into account the education and expertise of the

likely user (Goodings & Ketcham 2001). Hien *et al.* (2000) reveals that designers regard current tools as user unfriendly with very steep learning curves; moreover, the output generated could be extremely difficult to interpret and utilise for design decision-making. Ellis & Mathews, (2001, pp 1011) also confirm this and have identified that tools of today are:

- Complicated (not user friendly)
- Time consuming (too much input)
- Require a high level of theoretical knowledge (to make the input and to interpret the results)
- Information needed is not available during preliminary design.

Regarding the wish list of the tools the answers can be categorised after what level of education the respondents have. Those with a high school education or engineering diploma had no wish list. Those with an engineering degree expressed their interest in simplifying computer programs in order to make more use of them, whereas more educated people wanted tools that could be used to persuade the clients for better performance measures in the building. Examples of these are tools that can show the consequences of a chosen design in terms of reduced service life due to mould, rot or corrosion and cost analysis programs. Energy calculation, heat flow and airflow programs were not mentioned by any of the interviewees despite the fact that these areas all fall under the area of building physics.

Building industry related journals were also mentioned as being a tool that provides them with useful information. However, the interviewee did not state what specific types of journals they referred to.

In another civil engineering area, geotechnics, a trend is the growing number of experts (post doctoral) joining conventional firms instead of making a career within the university (Goodings & Ketcham 2001). This trend helps bring existing research into practice where it is most needed. Augenbroe (2002, pp 891) agrees with the idea of making more use of experts in the industry stating, “The latter trend recognizes that the irreplaceable knowledge of domain experts and their advanced tool sets is very hard to match by ‘in-house’ use of ‘dumbed down’ designer friendly variants”. This difference between having a tool, versus having an expert in the company is significant, and this was reflected in the results of the interviews. All consultants who had access to an expert made use of them constantly, and all stated that they would be uncomfortable working with moisture control problems if they did not have

access to their expert. They stated that they prefer having the expert than using a simplified tool. However, as shown in section 2.3.4, even the ability of experts in regards to moisture control can be questioned.

2.3.3 Confidence and level of awareness

Some of the consultants in the survey indicated that experience is very important in the industry when dealing with the performance of a building. However, this was not apparent when analysing the interviews. When looking at the experience level compared to the perceived level of awareness, i.e. how we thought that they see the whole picture of the design process combined with a comprehension of complex performance issues and an awareness of the current levels of technology, there did not appear to be any pattern. However, the level of education appeared to be related to their level of awareness. Figure 3 shows how we perceived the level of awareness for each person interviewed.

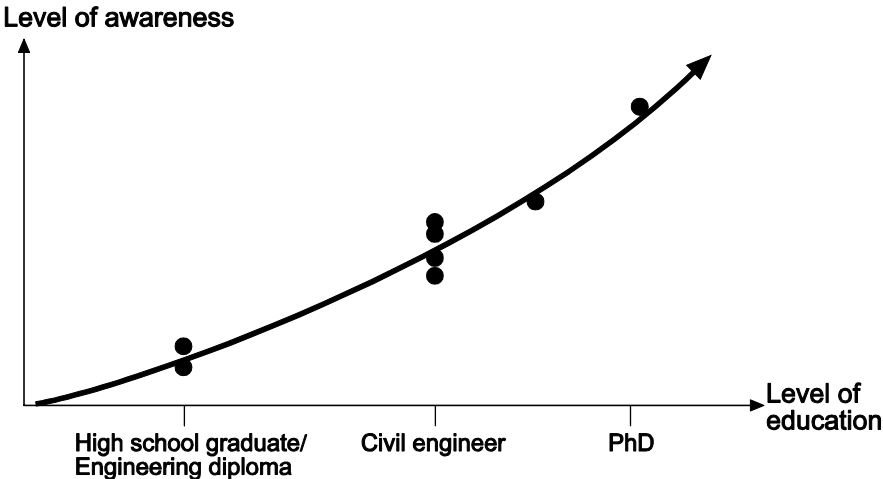

Figure 3: Illustration of the perceived relationship between education and level of awareness of building physics theory based on interviews.

It is important to remember that the engineers with diplomas and some of the civil engineers did not have access to an expert. This could affect the results in this study since education flows internally from the experts in the companies. Other companies with a combination of experts and engineers with diplomas working together may have a totally different level of awareness due to the expert's influence. However, further work done by Yverås (2009) shows that

one's ability with moisture issues may be more dependent on *when* the engineer received their education than it does on the level of education. In other words, the engineers with the newest education generally performed better in a test given by Yverås regardless of the level of their education and level of experience.

One of the key questions dealt with how comfortable the consultant feels when working alone on problems dealing with building physics. In most cases the answer to this question was related to whether or not they have access to an expert in building physics. If the consultant had access to an expert, they were usually not comfortable working with these issues and usually sought advice from their expert before finalising a design. The consultants in this category acknowledged that since the media attention began, they have felt even less comfortable with these issues and rely heavily on their experts. Those without an expert in-house were more prone to saying that they felt very comfortable with building physics issues.

One might easily draw the conclusion that people with less knowledge would suffer from insecurity more so than those with expert background. This was not the case during these interviews. Members with a diploma in engineering showed a great deal of confidence and no worries about the complexity of building physics. Confidence is defined here as the strength of a person's belief that a specific statement is the best or most accurate response (Peterson & Pitz 1988). So far, no study has been performed that examines if there is any correlation between mistakes in design and the level of building physics knowledge of the designer. However, there is a great deal of research, which indicates that people are often more confident than they are correct (Blanton et al. 2001). Blanton et al. (2001) states, that when trying to educate people, educators may meet obstacles from people's overconfidence about their knowledge. As the individual with the PhD said, "People *think* they can moisture proof a building, but they can't and I have to correct the problems later, which takes a lot of time."

Based on these interviews, the perceived relationship between confidence level and education level is illustrated in Figure 4.

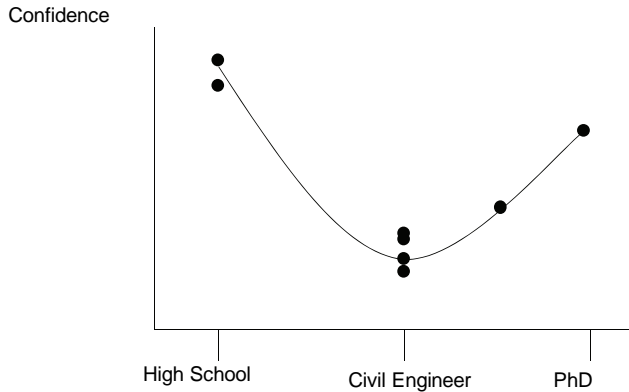

Figure 4: Perceived relationship between confidence level of the consultant and their education level.

Figure 4 has some interesting implications. The most significant one being that people hire individuals they feel comfortable with. People who have a lot of confidence in themselves are able to convince other people that they are the most qualified to solve the problem. This Figure questions this idea, showing that some of the most qualified people to deal with moisture problems have the least amount of confidence that they can solve the problem. This is due to the fact that the consultants have enough education to know how complex moisture problems are and they are not entirely sure how to fix the problem. Less educated consultants rely more on their past experience (more is written on why level of experience is not necessarily a good indicator of their actual ability with moisture issues in Paper VII and Section 2.3.4) and suggest solutions which they think would work. Unfortunately for the client, this problem of hiring the best people becomes even more complex than Figure 4 indicates when factoring in experience in combination with level and age of education. However, for the most part a client may hire the least competent person in part because of that person's confidence in completing the project correctly and quickly.

2.3.4 Lack of knowledge and experience

The group within the profession with the lower education level relies mainly on their experience. But if professionals rely mainly on experience, how do they know when there are gaps in their knowledge or whether some of their standard rules are no longer applicable (Barrett, P & Stanley 1999)? Decisions made without knowledge of their consequences can have dire effects (Ellis & Mathews 2001).

One of the interesting results from the interviews was that there was a lack of knowledge amongst the consultants in regards to moisture theory. Many consultants who had worked with moisture issues seemed to be uncomfortable with the subject, or did not appear very knowledgeable when dealing with moisture issues. As shown in section 2.3.3 Figure 3, a suspected relationship was presented between level of education and ability with moisture issues. Paper VII used systems analysis to analyse the system under which moisture consultants operate. The system took into account level of education (both formal and informal), ability with moisture problems, confidence etc. Yverås (2009) expanded on Paper VI by conducting further interviews with a diagnostic test. She observed that the relationship indicated by Paper VI was much more complicated; however the results could be explained by the system shown in Paper VII.

In order to understand this system and the CLD, the key terms must be defined.

Self education/understanding of moisture theory: this refers to the level of knowledge of the engineering consultant obtained from a formal education or courses. This is their level of theory. The more theory one has, the better the chance that they understand the problems and the solutions.

Ability with moisture issues: This is the ability to apply theoretical knowledge in order to solve practical problems. It is important to note that ability is not to be confused with how good someone thinks they are with moisture problems, this refers to their actual ability. The concept of how good someone thinks that they are has been researched before and is put into the context of the Swedish construction system in Sunding (2006).

Questions: This refers to questions that may arise in dealing with a moisture problem or questions that the consultant may have.

Answers: This refers to the *correct* answers a consultant has to specific questions.

Acquire projects: This is the ability to obtain new projects.

Completed project: We assume here that each time a consultant begins a project they complete it and add it to their merit list (CV or Résumé).

Experience (years in field): Refers to the number of years that the engineering consultant has been working with moisture problems in the field. Experience also refers to their memories of their past projects and includes the past performance of chosen solutions within each project (if any).

Confidence: This refers to the confidence level of the engineering consultant in dealing with moisture problems.

Feedback from past projects or review of state of knowledge: Time allowed for the engineering consultant to review old projects (what worked, what did not work, why or why not), read literature regarding moisture theory and practise or discuss cases with other co-workers.

2.3.4.1 The System Explained and Discussed

In order to understand the results from both Paper VI and Yverås (2009), which show that the ability of the engineering consultant to solve moisture problems appears to be related primarily to their level and year of education and not to their experience (years in the field), a CLD of the system in which the moisture consultant operates was developed. This CLD should be valid for all moisture consultants with different consultants utilizing different stages of the system.

2.3.4.1.1 Learning Stage

The first part of the system is shown in detail in Figure 5. This part can be seen as the education/learning stage.

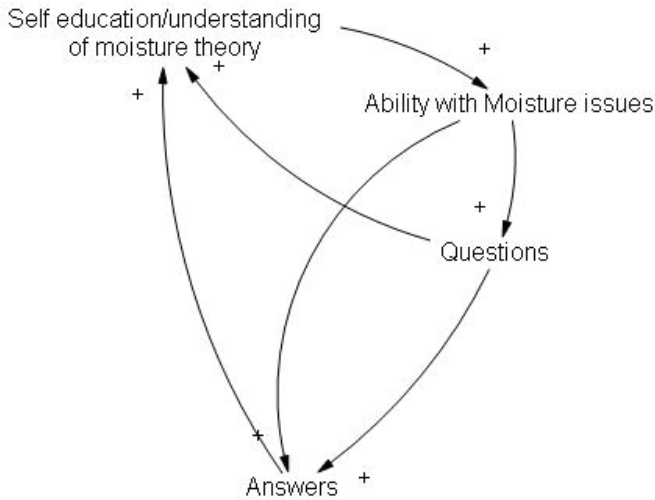

Figure 5: The learning/education phase.

The system begins with some kind of formal education on the topic of moisture theory. With more theory, the individual has more ability to deal with complex moisture problems. Sometimes the level of theory must be upgraded in order to answer questions that may arise when working with some problems. Additionally, answers provided by others can also increase theoretical knowledge. As their ability increases, the number of questions also increases because they have enough knowledge to realise the complexity of the issues. Some of their questions can be answered based on their current level of knowledge. However, sometimes more education is needed (self study via books and literature or courses) to increase their ability with moisture issues allowing them to answer questions they may have.

2.3.4.1.2 Working Stage

In the next part of the system, Figure 6, the consultant begins working with moisture problems.

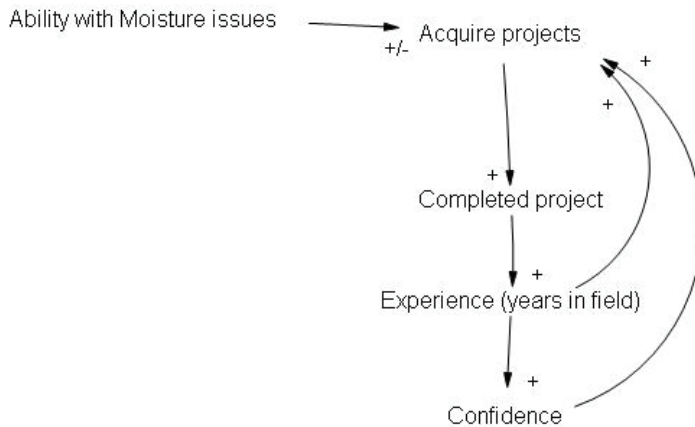

Figure 6: The applied phase where theory is put into practice.

They acquire projects based on their ability with moisture issues, their experience and even their confidence level. Their confidence level refers to how well the consultant sells themselves and how they feel about themselves. We assume that the consultants finish the projects they begin, and add them to their CV. In addition they gain experience, which refers to their memories of past projects and the number of years they have worked with moisture problems. Over time as they gain more experience their confidence level increases because they feel more comfortable that what they do and know about moisture problems is correct. This in turn increases their chances of acquiring new, more complex problems to solve.

Putting together the first two stages we get a system that is shown in Figure 7.

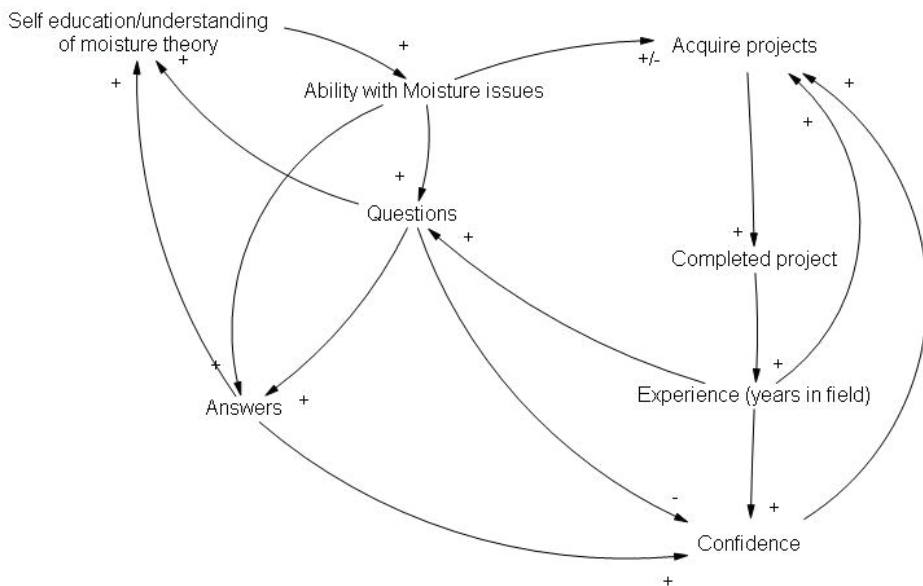

Figure 7: The combination of education and learning phases.

In this system, there is a connection from experience to questions; this connection refers to questions that develop over time as one works longer. There is also a connection from questions to confidence showing that the more questions you have that are un-answered, the less confident the consultant is in their ability to solve moisture problems. Countering this, there is also a link showing that the more answers that the consultant has, the more confident they are.

It is suspected, based on conversations with numerous consultants, that this is the system in which moisture consultants currently work under. They complete some kind of education, and then begin working in the field. The consultants may have some questions, but they are not encouraged to answer these questions or gain the knowledge needed to understand the question. Their answers are almost always based on the information they received during their education.

As shown in Paper VII and Yverås (2009), this system can prove to be disastrous. Consultants with a low level of education and a low ability with moisture issues can have a very high confidence level convincing the client that they know a great deal about moisture problems. If this individual also has a very high experience level then most projects they will work on run a very

high risk of failure. However, blame cannot be placed on the individual because this system is flawed and does not allow for them to learn from their past projects. They may never know which projects were good or which ones went bad. This was very apparent from the interviews conducted in Paper VI when the highly educated moisture expert said they spent most of their time correcting other people's mistakes.

Yverås (2009) expands on this observation somewhat. It was observed, from a new set of interviews, that the 'moisture experts', with various levels of education and a lot of experience (i.e. older education), may not have the same ability as those with newer education and little experience. The two lowest scoring groups in a diagnostics test were those with the highest level of education and those with the most experience. Interestingly, the group of consultants with the least amount of confidence with a mid-level education outperformed the other groups with less and more education. From this study it appears that perhaps even the highly educated experts with a lot of experience are being caught in the model shown in Figure 7 where they rely on their high level of education and their experience to gain new projects, without continually updating their knowledge.

This system also supports the finding from Paper VI which indicated that the consultants with a Master of Science in Civil Engineering were not very confident when working with moisture issues. The explanation using this model shows that they have enough ability with moisture problems to recognize that they have a lot of un-answered questions, lowering their confidence level. In this scenario, the Civil Engineer is a much better choice of consultant compared to the experienced, confident consultant with a lower ability and low level of education or, as Yverås (2009) shows, the confident expert with a lot of 'old' education. Unfortunately, assuming that the price was not an issue, most clients would choose the confident consultants because they give the illusion of having a higher ability.

2.3.4.1.3 Feedback Loop

The system shown in Figure 7 is due to fail because it is incomplete. In order for consultants to improve over time they must be allowed to seek feedback from past projects. This new system can be seen in Figure 8.

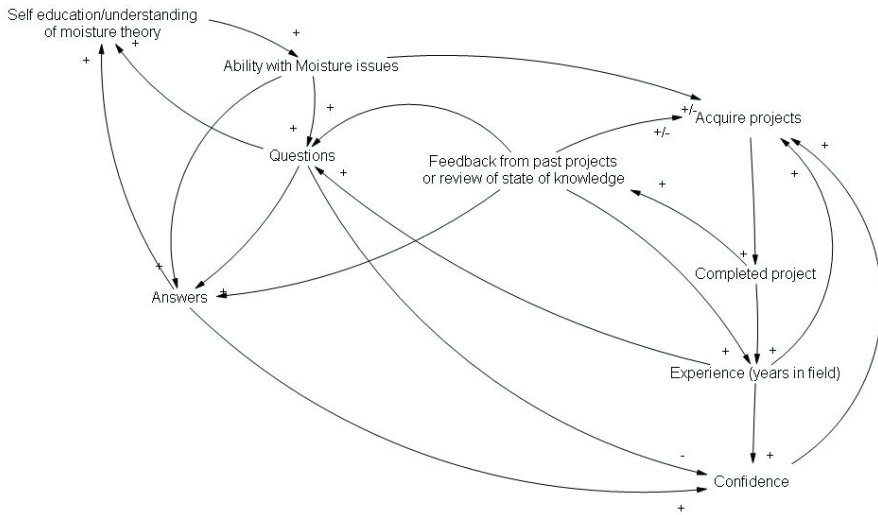

Figure 8: A proposed system of working to ensure the steady development of moisture consultants over time.

When the feedback component is added, the consultant can make more use of their experience.

The most common version of the model shows that the consultants know what they did in the past, but do not know how those solutions performed. By reviewing past projects and acquiring feedback, they know what they did in the past and they find out if their solution worked and if not, why. Whilst this component does not directly affect their ability, it does increase the number of questions and answers they have indirectly increasing their ability. This also regulates their confidence level so that they feel confident, but not over-confident, when confronted with difficult moisture problems and they also have a better idea of their limitations.

This system appears to be the same system used by some moisture experts within some companies. One interviewed engineering consultant stated that their in-house moisture expert spent a lot of time reading reports when not working with specific projects. Unfortunately this system is not used by the majority of moisture consultants because they are not allowed time to seek feedback or review current knowledge.

One source of feedback was not added to the definition of 'Feedback from past projects'. This is verbal feedback from co-workers. For example, a younger

engineer might get feedback from an older, more experienced engineer. This is not included in the definition because there are too many unknowns. The most important is that it is unknown if the older engineer was caught in the previous loop without proper feedback. If that is the case, the younger engineer may actually decrease their ability with moisture issues since we have seen in Paper VII and Yverås (2009) that their abilities are based on their levels and year of education! In this scenario, it is the more experienced engineer with the older education that would benefit from the newest engineer with the newest education.

Of course the opposite can also be true in regards to verbal feedback. If the more experienced engineer used a feedback system in such a way defined by the model, developing themselves as their career progressed, the younger engineer would greatly benefit from their knowledge of past projects. In this scenario education is not the key component. This would allow the younger engineer to develop even faster, gaining some of the ability from the more experienced engineer.

According to the model in Figure 8, in order to ensure consultants improve over time is to incorporate feedback and education into the working environment. Instead of constantly working on new projects, time must be made for reflection and review of completed projects. In Sunding (2006) it is maintained that this is not enough in situations that are potentially threatening or embarrassing, e.g. if it involves discovering inconsistencies or flaws in ones own conceptions which might invoke anxiety which will trigger psychological defence. This is also stressed by Argyris et al. (1985) who have developed a special method to deal with the defence – the double-loop-learning.

One tool that can help to ensure that consultants improve over time and get the feedback that they need is to introduce the idea of knowledge management into the organisation. Used in combination with a quality assurance program such as ISO 9000, knowledge management can help consulting engineers maintain a high level of skill with moisture problems based on recent developments in the field. This could also provide and produce documented feedback for others within the organisation to study and review.

2.3.4.2 Other Applications

This problem regarding learning and development is not limited to moisture issues. Recent research by Heylighen et al. (2007) discusses a similar issue with architects and how they are trying to encourage architects to seek more

knowledge from past projects by the use of an on-line database of case projects called DYNAMO. In this case, some architects look negatively upon past cases since they do not want to be 'contaminated' by past designs in their effort to be seen as individuals.

In the case of engineers, the main problem is that there are currently no tools of this nature available. In some companies, employees are not allowed to use working hours to research old projects using more traditional methods.

In Norway engineers can assess some information on different building details. They are in the form of Building Design Research Sheets, and are published by SINTEF (SINTEF 2007). For a yearly subscription, subscribers have access to a database containing assessments regarding a number of different design solutions. These types of tools would allow engineers to check the current body of knowledge against their designs in order to determine if their detail is documented or not. This type of information is a type of feedback in the confidence loop and while it may not contribute to their understanding of moisture problems, it will give them the experience of knowing whether they were right or wrong and effect the confidence loop accordingly.

3 Frost Penetration Model

This section is based on Paper VIII. For more detailed information please read Paper VIII.

As energy becomes a more central focus in regards to building performance, one of the easiest ways of decreasing the energy use in buildings is to increase the insulation thickness. This includes the insulation under the foundation of a building. In Northern countries this must be balanced with the frost penetration, or, how far the frost front moves under the foundation. Too much insulation and there is a risk that the frost penetrates under the foundation causing lift and damage to the building. Too little insulation and the building uses more energy than necessary. This issue is not applicable to buildings constructed on permafrost. In this case the building would probably be damaged if heat from the building melted the frost under the foundation.

Current thermal simulation programs make a number of assumptions which are problematic for calculating frost penetration. One is that the heat transfer coefficient is constant for different temperatures and RHs. In addition, many models do not take into account latent heat, which is the amount energy absorbed or released per gram by a substance, in this case water, when it changes phase from liquid to solid.

Another significant issue is that these models cannot take into account snow cover. Each one of these issues can cause significant error in the calculation by themselves.

3.1 State of the Art

Most northern countries rely on their building code to prevent frost penetration damages. This usually is based on the frost penetration depth and is not related to the construction. Roots & Hagentoft (2005) state that most studies of frost penetration do not include the insulation thickness and due to the thick insulation layers found in a modern Swedish slab on the ground foundation, the ISO 13793 standard cannot be used. They recommend thermal simulations.

There is currently one commercial tool available as a part of a geological tool package which is able to simulate the effect of latent heat under buildings and around pipelines (GEO-SLOPE 2008). However, this tool is expensive.

Considering the concerns discussed in Section 3, where consultants feel tools are too expensive, a cheaper tool was needed.

The next-best tools currently available to consultants for solving this type of problem are the HEAT-series programs (Blomberg 1996). They are popular software commercially available for solving two and three dimensional thermal simulation problems and are not excessively expensive.

3.2 Method

The calculation engine for Thermoground - LTH is called the JAM calculation engine created by Arfvidsson (1989). The JAM calculation engine was originally designed to do moisture calculations but can easily be modified to run thermal simulations. The difference between this calculation engine and the one found in the HEAT simulation programs is that the JAM engine can use variable material properties based on temperature. The HEAT programs use a constant value.

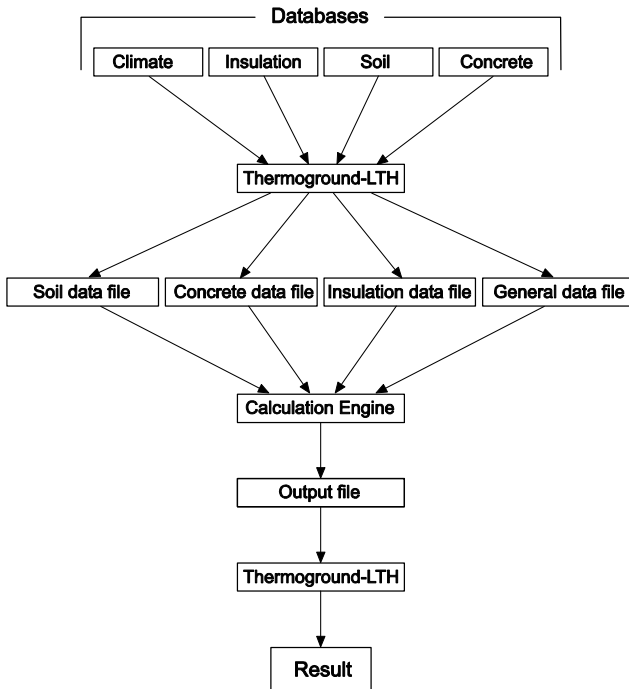

Figure 9: The file to software relationship for Thermoground - LTH.

Figure 9 shows a diagram of how the program functions. A number of databases supply the material data to the program. The dimensions are entered into the program as well as a number of options available for each design type. The program generates data files for each component that is processed by the calculation engine. The calculation engine simulates the desired conditions and creates an output file that is converted into images by the main program.

The program has a predetermined design template for a slab on the ground foundation. The user enters the dimensions for the design, chooses the types of materials from the databases and runs the simulation. The Thermoground – LTH program creates four data files that are used by the calculation engine. The calculation engine creates an output file and graphical results are created by Thermoground - LTH program showing the temperature profile for a period of every 10 days for year 2 and year 12. The reason year 2 is looked at is because the risk of damage due to frost penetration is greatest during the first year of a building's lifetime, before the thermal 'pillow' under the foundation is stable. Since it is unknown exactly when the building is constructed and unlikely that it will be finished during the winter, year 2 was chosen to be monitored. This program is unique in that it has a simple interface program and is more realistic than the other popular thermal simulation software for simulating temperatures under a building's foundation because it takes into account the material's properties during three phases; when frozen, during melting and freezing (heat of fusion), and unfrozen. However, it lacks any drawing and analysis functions.

The databases are external so that they can be updated individually. The input file and climate files, which are monthly average temperatures and a snow resistance value of $0,3 \text{ W}/(\text{m}\cdot\text{K})$ snow can also be edited manually. It is advised not to modify climate or input files without working knowledge of the calculation engine.

3.3 Results

The initial results show that the program has good correlation to the frost penetration depth for northern Sweden using the corresponding snow and climate data from a specific location. Simulations with HEAT2 showed that Kiruna, a northern city in Sweden, should have permafrost between buildings, which is not the case. This is because HEAT2 cannot take snow into account. It also cannot have a variable boundary resistance although one solution may be to use the ground's surface temperature instead of climate data. The same foundation type simulated with Thermoground – LTH showed a more realistic

result, no permafrost and an average ground temperature of about 2-3 °C. This was mainly due to the snow's resistance above the ground. Simulations were done with constant thermal properties and resulted in a ground temperature of around 0°C.

The HEAT simulation engine is based on a similar heat transport theory as the JAM engine found in Thermoground – LTH, but has a few important differences. At the time of writing, HEAT cannot take into account latent heat of fusion during the phase change of the water into ice and vice versa. HEAT cannot vary the heat transfer coefficient of the material based on its temperature. Heat cannot modify surface resistances dynamically over time thus simulating the effect of snow. This means that the results from a HEAT simulation yield deeper frost penetration than is found in reality indicating that less insulation should be used on the building, or that the building's foundation should be deeper than the frost penetration. Due to the fact that the JAM engine takes into account these variables, the Thermoground – LTH initial results show that because of the insulating effects of snow and dynamic thermal conductivity, it is possible to increase the insulation layer under the foundation thus decreasing the energy use of the building. (Blomberg 1996)

It is important to note the limitations and assumptions used in Thermoground – LTH. The climate data is a sinus curve based on the average temperature. Ideally the program should be using real climate data with hourly values. The snow layer is only a surface resistance in the calculation based on monthly average snow depth values. Snow's thermal resistance can also vary a great deal depending on the type of snow that is on the ground. It was also developed for a specific problem. If it is not to be used for frost penetration under a foundation, then a tool such as HEAT2 should be used instead.

4 Moisture Transport Model

This section presents work that was done for this thesis in the fields of isothermal and non-isothermal moisture transport. This work is on-going, so it is only partially presented here. It is a continuation of work done by Arfvidsson (1990), who stated that the determination of non-isothermal moisture flow coefficients requires a prior knowledge of the isothermal moisture flow coefficients for the material at different temperatures. In Section 4.2, a method and a first sequence of measurements for isothermal moisture flow properties for a wood sample at various temperatures and humidity levels are presented. The full evaluation to determine the isothermal moisture flow properties are beyond the scope of the thesis, but a few promising results are reported. A new method and a few results to determine non-isothermal moisture flow properties are presented in Section 4.3.

4.1 State of the Art

The properties of building components are dynamic. Temperature and RH are constantly changing in walls, floors and attics. Isothermal moisture transport models are not suitable to predict what happens in real life. They cannot take into account the changes within a material when both the temperature and RH change. If one wants to simulate what happens in a wall or other building component exposed to the outdoor environment over time, one must use a non-isothermal moisture transport model with the appropriate material data for different temperatures and moisture levels.

There are many different theories which try to describe moisture transport for both isothermal and non-isothermal moisture transport. The first and oldest theory of moisture transport, upon which most current theory is based upon, is Fick's law of diffusion (Fick 1855). This law describes the movement of a substance through a substrate due to a difference of concentration (i.e. a substance with a high concentration will travel to space with a lower concentration until the two spaces have an equal concentration). While Fick's law works for homogenous materials, it does not work for heterogeneous materials. Moisture transport in wood is a different type of problem from what Fick's law describes due to the complexity of wood's structure. In other words, there is more than one way for a substance to travel within a wood sample to the space with a lower concentration. There is no defined way to describe this system of flows and is usually classified as a 'non-Fickian' moisture transport.

There has been a lot of work done in the past looking at both isothermal and non-isothermal moisture transport in wood (Avramidis, S. & Siau 1987; Avramidis, Stavros & Wu 2006; Bogoslovskii 1965; Carmeliet & Roels 2001; De Vries 1987; Galbraith, G. H. et al. 1998; Glass 2007; Globus & Nerpin 1966; Li et al. 2006; Nelson 1986, 1991; Peuhkuri 2003; Segerholm 2007; Siau 1983a, 1983b, 1985; Siau, eene & Avramidis 1993; Skaar & Siau 1981; Strumillo et al. 1994; Tanish 1986; Wadsö 1993). It is beyond the scope of this thesis to describe all the current theories of moisture transport since other authors have discussed these theories in detail. The general trend that can be seen was stated by Wadsö (1993) when he concluded that in the future a model is needed to describe the moisture transport through the wood cell walls and that “it should not be a numerical or quasi-physical model with many fitting parameters.”(pp 77) The common ground with most models is that they have assumptions and use curve fitting in order to provide nice results. There is currently a lack of models which describe moisture transport with physical models.

4.2 Isothermal Moisture Transport

A fast, transient technique for measuring variable diffusion coefficients was developed by Arfvidsson and Cunningham (2000) in the 1990's. If the sorption curve for the material was known, this method allowed the researcher to determine diffusion coefficients for various moisture states and temperatures within hours or weeks and not months. This method is very similar to that used by the modern gravimetric vapour sorption analyser called the Dynamic Vapour Sorption (DVS), first developed in 1991.

As mentioned above, both the isothermal and non-isothermal coefficients must be known in order to calculate the non-isothermal moisture transport. The DVS 1000 and DVS Advantage were used to determine sorption/desorption curves and the variable diffusion coefficients. The following sections will describe the DVS control criteria used for each sample and temperature, followed by the sample preparation.

4.2.1 Isothermal Measurements

The DVS is an instrument which can measure the mass over time of a sample which is exposed to different concentrations of a vapour at defined temperatures. The vapour is transported to the sample in a dry nitrogen gas stream. In this case, the vapour which the sample was exposed to was distilled water vapour. In this study two different DVS instruments were used, the DVS

1000 and a newer DVS Advantage. The reason for the switch to the DVS Advantage was that the DVS 1000 had a difference in the reference and sample temperature gas flows. It is believed that this temperature difference was due to inadequate insulation of the climate chamber. This difference in temperature was affecting the RH of the sample gas flow and even causing condensation at high temperatures when the RH was supposed to be around 90%. For the purposes of this study, the advanced features of the DVS Advantage were not used and was operated using the same method as the DVS 1000, which is only monitoring mass over time when exposed to a specific concentration of water vapour and temperatures.

The DVS can be programmed to change temperature and/or RH based on a number of different criteria. For these experiments, the DVS was programmed to only change RH after a set amount of time. The sample was not allowed to reach equilibrium. The times were modified for each temperature since the moisture transport was slower as the temperature increased. The mass of the samples were weighed and recorded every minute. Table 1 shows the times in minutes for each RH step change for each sample type.

Table 1: DVS program times in minutes for the samples with various temperatures and relative humidity.

RH (%)	Longitudinal Flow Times (min)			Tangential Flow Times (min)			Radial Flow Times (min)		
	10°C	20°C	30°C	10°C	20°C	30°C	10°C	20°C	30°C
20	400	400	400	800	800	800	400	800	800
40	400	400	400	800	800	800	400	800	800
60	400	400	400	800	800	800	400	800	800
70	600	600	700	1200	1200	1200	600	1200	1200
80	700	700	800	1400	1400	1400	700	1400	1400
85	700	700	800	1400	1400	1400	700	1400	1400
90	900	1000	1000	1800	1800	1800	900	1800	1800
92	1000	1000	1000	2000	2000	2000	1000	2000	2000
95	1200	1200	2000	2400	2400	2400	1200	2400	2400

Salt solution calibrations were done after each temperature change as per the manual to check that the instruments were measuring in the correct RH range. In addition, the DVS Advantage was programmed to perform a self cleaning of the sensors between each temperature change.

Dr. Harald Säll, Lecturer from the department of Wood and Forest Technology at Växjö University, was contacted in order to obtain samples of Norway Spruce (*Picea abies*). This species of wood was chosen because it is commonly used as a building material in Sweden.

Two variations of Norway Spruce samples were obtained, one slow growth and one fast growth. Both had similar diameters and total heights. However one tree was around 80 years old and the other was around 150 years old. The

samples came from the bottom sections of the trees approximately 3 meters from the base and were about 1,5 meters high.

The samples were brought back to Lund University and stored in a climate room with a temperature of -10°C and 60% RH. They were cut up into 17mm thick slices and numbered according to Figure 10. This allowed for easy extraction of smaller samples for two different types of moisture transport typically measured in wood, radial and tangential. In addition, a number of disks were also cut in order to easily make small samples for longitudinal moisture transport. Three small samples representing the moisture transport for three directions in the wood were drilled with a plug set measuring 4,69mm in diameter and cut to a thickness of about 5mm. All were taken from the heartwood and not the sapwood of the slow growth tree. One sample represented longitudinal flow, one radial flow and the third tangential flow. The details of the small samples are given in Table 2.

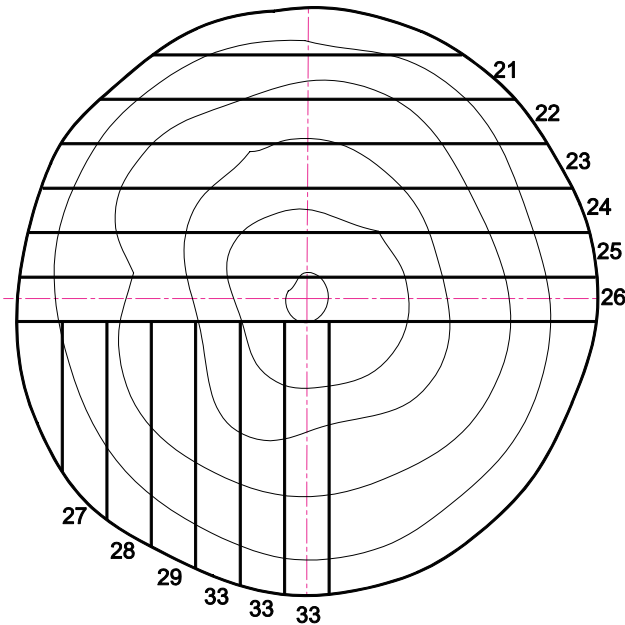

Figure 10: Illustration of how the sample was cut and labelled. In addition to these, other samples were cut across the tree producing 17mm thick cross sections of the tree.

Table 2: DVS sample data.

Sample	Dry mass	Mass with seal	Thickness	Density
Longitudinal flow	0,0529 g	0,1457 g	5,26 mm	590 kg/m ³
Radial Flow	0,1023 g	0,3168 g	6,68 mm	680 kg/m ³
Tangential Flow	0,0650 g	0,1975 g	4,62 mm	810 kg/m ³

The DVS samples were placed in a jar with desiccant and placed in an oven to dry at 105°C. After the DVS samples were dry they were measured and weighed. Then the main body was sealed with Platton, which is a butyl rubber sealant. The edges of the DVS samples were left exposed so that double-sided drying and absorption could take place, reducing the time in the DVS.

Part of the sample preparation included deciding on how to seal the sample. A study done by Svennberg and Segerholm (2006) compared a number of different sealants including aluminium tape, PVC-tape, beeswax, silicon, Platton tape, epoxy and Parafilm. They concluded that Platton was a very good sealant when used with wood. A simple test was conducted to look at how well Platton sealant performed compared to only using Parafilm, and when using a layer of Parafilm over the Platton sealant. This was a means of covering the Platton sealant so that the sample could be handled without having other materials sticking to it.

Twelve glass vials of water were sealed with the different systems. Samples one to three had the Platton/Parafilm combination, samples four to six were the same but inverted, samples seven to nine were only Platton sealant and samples ten to twelve had only Parafilm. The samples were weighed over a period of 260 days to determine the loss of moisture through the sealants. The samples were stored in a climate chamber with a temperature of 20°C and a RH of 50%.

4.2.2 Results from Isothermal Measurements

This section will first look at the issue of different DVS sample densities as seen in Table 2. Then the results from the sealant tests are presented. Finally results from the isothermal measurements using the DVS are presented, analysed and evaluated.

It was noticed in Table 2 that the densities varied greatly between the three DVS samples, even though they came from the same tree. Jyske et al., (2008) found that this is not unusual, and that there is more variation in wood density within a tree than between many trees. This is due to the different properties around the annual rings and how they increase in density away from the pith. In the case of these samples, the density would be most affected by the percentage of earlywood and latewood in each sample due to the small size of the samples.

The results of the different sample sealants showed that the combination of Platton tape and Parafilm provided the least moisture flux.

Table 3: Sealant test results

	Sample	Moisture Flux (kg/(m ² s))
Platton + Parafilm	1	4,9E-10
	2	7,98E-09
	3	5,60E-10
Platton + Parafilm (inverted)	4	3,01E-09
	5	3,06E-07
	6	3,16E-07
Platton	7	1,96E-09
	8	2,78E-08
	9	1,00E-08
Parafilm	10	2,95E-08
	11	2,83E-08
	12	2,54E-08

In addition to providing moisture flow data, the test also revealed some weaknesses with the sealant systems. Samples 5, 6 and 8 developed visible holes and breaks in the seal during the course of the experiment due to a suction created in the vial. In samples 5 and 6 the Platon caused the Parafilm to break because it was stretched beyond its stretching point. Sample 9 may also have a hole which is not easily visible since the performance is comparable to sample 8. Suction was visible in all cases, however there were no visible breaks in the seal in the remaining cases. Based on this, it was decided to use the combination of Platon tape and Parafilm for the non-isothermal moisture transport experiments.

For the isothermal moisture transport measurements in the DVS, only Platon tape was used to seal the sample since it was small and the sample would be exposed for a relatively short time at each humidity level.

Figure 11 shows the measured moisture uptake for longitudinal flow at 20°C. The relative humidity is shown as 18 steps with a total time of 12 600 minutes, starting with a step from 0 to 20% RH. All 9 measuring sequences are shown in a simpler format in Appendix III.

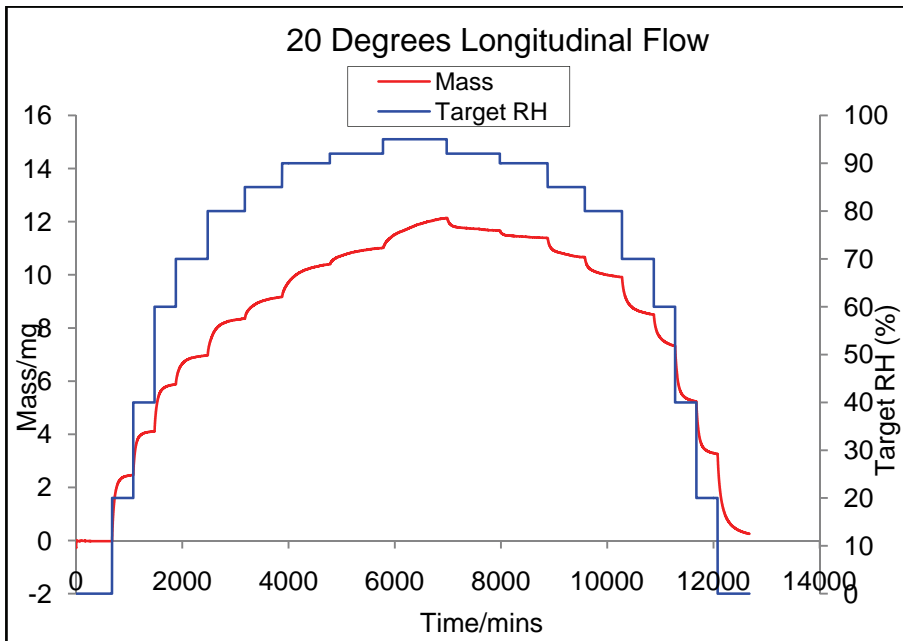

Figure 11: Example of the data output from the DVS. This example shows the longitudinal moisture uptake at 20 °C.

4.2.3 Preliminary evaluation of Isothermal Measurements

The above measurements are to be used to determine moisture diffusion coefficients and sorption isotherms as functions of moisture content and temperature level. A goal is to establish a rapid method with relatively short time intervals for each step in relative humidity. This is obtained by parallel numerical simulations to avoid waiting until steady-state conditions are fully attained. Another main goal is to try to contribute to the basic understanding of these complex phenomena. However, these evaluations are beyond the scope of this thesis. They will be reported after further studies. Here, a few, very preliminary results for *longitudinal* moisture uptake are presented.

An important parameter is the surface moisture transfer coefficient of the sample, β , which is dependent on the air velocity near the surface. The moisture flow across the sample surface is equal to β times the difference in, for example, relative humidity between free air and sample surface. For each

change in RH for all the sequences of measurements, the surface resistance was determined by calculating the slope of the mass-time data for the first few minutes after the step change in relative humidity. In theory this is the time when the mass change is only due to the amount of moisture just penetrating the surface of the material. It is also when the sample has the largest increase in mass per time.

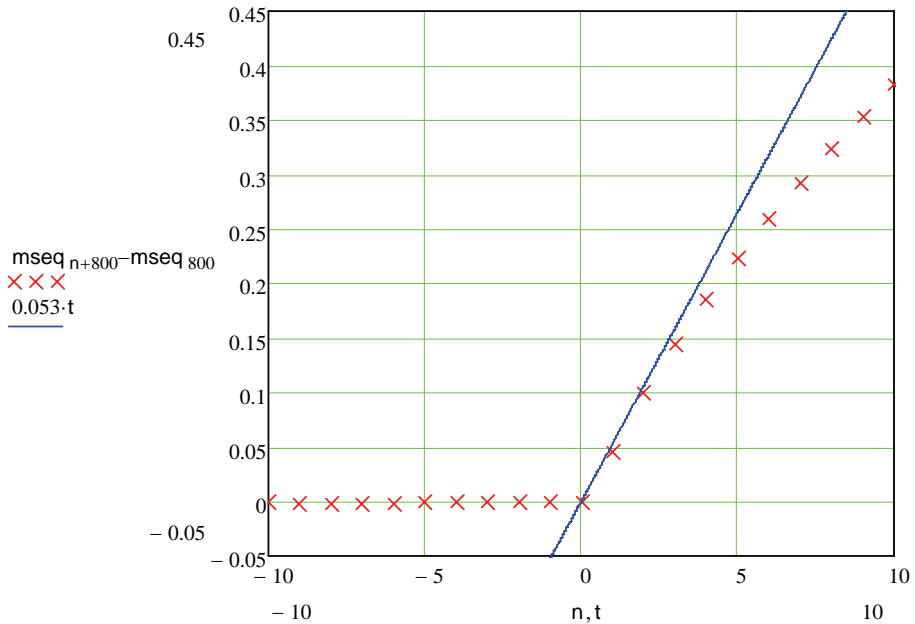

Figure 12: Example of how the surface resistance was calculated for each state change using MathCad 14.

Figure 12 shows an example of how the surface resistance was determined by fitting in MathCad 14. All these fitting gave quite stable and consistent results. The conclusion is that it is possible to determine the surface moisture transfer coefficient with good accuracy.

A first model that has been tested for longitudinal moisture flow is a two-level model. The moisture of the sorption isotherm is divided into two parts: an “outer” more accessible part with a diffusion coefficient that depends on the outer moisture content and an “inner” part. The inner part is, at each coordinate level, supplied with moisture from the outer part by a moisture-

dependent transfer coefficient multiplied by the difference in moisture state between inner and outer parts.

A problem with this model is the large number of parameters. There are two sorption isotherms, a diffusion coefficient and the inner transfer coefficient. All four are functions of the moisture state, which are to be fitted to the measured moisture uptake. The results from these efforts were not very good. It was difficult or impossible to get stable results. This type of two-level model does not seem to provide a manageable representation of the moisture uptake.

The moisture uptake in the longitudinal direction is quite different from the uptake in the tangential and radial directions. The height of the samples is only 5.3 mm and the length of a typical wood cell around 3 mm. This means that most of the inner surfaces of the lumen are expected to be directly exposed to the surrounding air via diffusion of water vapour along the lumen. In the transverse directions, the direct diffusion is blocked by the cell walls. Open bordered pits provide direct access, but over much more limited areas.

The results for the longitudinal uptake in these very small samples make it possible to analyse the moisture uptake within the very thin walls, since these are directly exposed to the outside air. It may be noted that the diffusion coefficient (referring to water vapour concentration) in humid air is around $25 \times 10^{-6} \text{ m}^2/\text{s}$. The square $\sqrt{t \cdot 25 \cdot 10^{-6}}$ is a measure of the propagation of a change in water vapour concentration in humid air during a time t . This means that the disturbance has propagated 0.005 m or 5 mm in one second. The outside step change of RH is felt inside an open lumen after a second, while we consider a process in a time scale from minutes to a few hours. There is now a surface moisture transfer coefficient β between the outside air and lumen surfaces in the small sample. By fitting as in Figure 12, we got a stable value for longitudinal moisture uptake at 20 °C (0.08 for a difference in RH/100).

A complication is that the cell walls have variable thickness in the range 1 to 8 μm . A detailed investigation of the distributions based on direct measurements of the cell wall thickness showed that there are two quite dominant sizes: 2 and 4 μm . (Zillig 2009)

The above considerations for longitudinal moisture uptake lead to a model with two cell wall thicknesses. There are two parallel diffusion processes with the same diffusion coefficient in the wood walls depending on moisture level.

The walls experience, by assumption, the same time-dependent surface moisture state, which is coupled to the outside relative humidity via the parameter β . A further parameter is the relative fraction f_{thin} of thin walls.

The model now has three parameters: β , f_{thin} , and the width ratio between thick and thin cell walls, which was chosen to 2. The sorption isotherm and the diffusion coefficient in the cell walls as function of moisture content in the solid wood are the unknown functions to be determined.

A numerical model of the two diffusion processes coupled to the imposed RH in the surrounding air was developed. The thinner wall used 10 numerical cells and the thicker one 20 cells. Around 5000 time steps were used for each step in RH. The sorption isotherm and the diffusion coefficient were approximated by piecewise linear functions, where the end values in each RH interval were determined by fitting. A calculation of the moisture uptake for a RH interval requires a few seconds of computer time on an ordinary PC.

The parameters $\beta=0.08$ and $f_{\text{thin}}=0.4$ were fitted for the first RH step from 0 to 20% for longitudinal moisture uptake at 20°C. The fitting of the piecewise linear sorption and diffusion functions were done in the following way. Consider for example the third RH step from 40 to 60% RH. The two functions are known up to 40% from the previous fittings. There are unknown values at 60% RH for sorption moisture content and diffusion coefficient. The calculated moisture uptake during the step is compared to the measured curve for different values. It was fairly easy to obtain a good fit after gaining some experience.

The first result is shown in Figures 13 and 14 for the sorption isotherm $w_{\text{sorp}}(\text{RH}/100)$ and the diffusivity $D(w)$ in the wood cell walls. The circles show the fitted values. These data, which are preliminary, are presented here to show that the considered model seems to be quite promising. The sorption isotherm has the expected form.

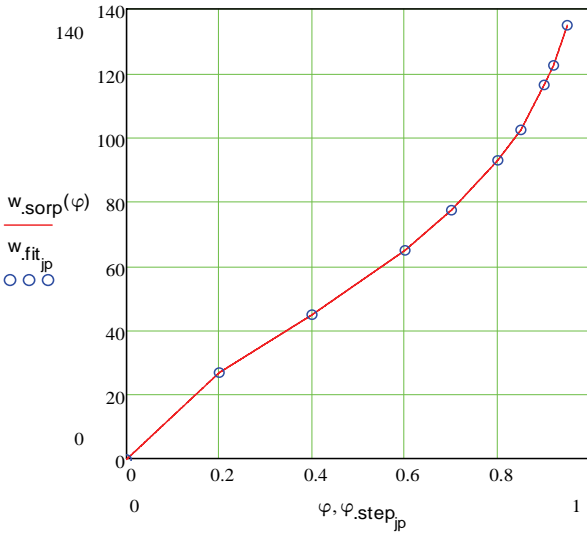

Figure 13: Fitted sorption isotherm from longitudinal moisture uptake at 20°C.

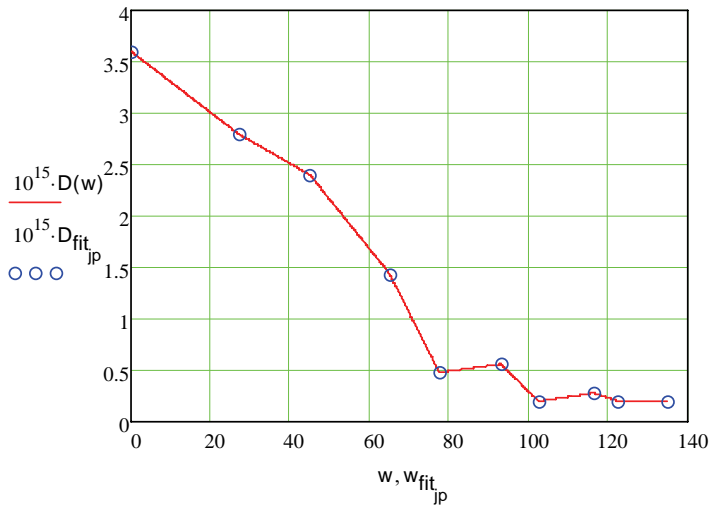

Figure 14: Fitted diffusion coefficient $D(w)$ for moisture flow in the cell walls (from longitudinal moisture uptake at 20°C).

The function $D(w)$ for the diffusion coefficient is quite interesting. It represents the diffusion inside single solid cell walls. The value falls rather

linearly from 0 to 75% RH. After that the values show a slightly falling trend. The values are very small with the exponent 10^{-15} . The fitted values of $D(w)$ depend on the square of the wall thickness. The presented values are valid when the thinner walls are $2 \mu\text{m}$ thick.

The moisture migration on the wood level above single wood cells involves three basic components: the above diffusion in the cell wall, water vapour diffusion in the cell lumen and moisture transport through bordered pits. The bordered pits may be open or closed, or perhaps partially open. The directly measured values for diffusion in cell walls are quite important for any aggregated model of moisture migration in wood.

The moisture uptake in *tangential* and *radial* directions will depend on the diffusion through the cell walls, which may be quantified using the above values $D(w)$, and, in particular, on the moisture transport through the bordered pits. The measurements of radial and tangential moisture uptake may then be used to identify in a rather direct way the moisture flow through the bordered pits. The measurements presented in Appendix III may open new possibilities to analyse the complex moisture migration in wood in a quantitative way.

4.3 Non-Isothermal Moisture Transport

Moisture transport in materials is a complex phenomenon that has been studied quite a lot since the 1950s however it is still not fully understood. Today's modern theory of moisture transport began with Philip and DeVries (1957) when they developed a theory of moisture transport which divided the total flow into liquid and water vapour flow and described this flow by equations involving gradients of moisture state and temperature. The difficulty with non-isothermal moisture transport is that it is impossible to directly measure these separate flows; only the sum is measurable. Another difficulty is that assumptions are made regarding the mechanics of the moisture flow, in this case that the moisture diffuses through a homogenous material. For wood and other organic materials, there are air spaces, cell walls of various thicknesses, and pits which can open and close. Not only does moisture move through all these components, but the components are also able to absorb moisture and physically change their geometry because of the moisture.

Other experiments have been designed to try and quantify each effect independently through a combination of monitoring the steady-state moisture transport through a material with salt solutions using a combination of isothermal and non-isothermal experiments (Arfvidsson & Cunningham 2000; Avramidis, S. & Siau 1987; Bogoslovskii 1965; Carmeliet & Roels 2001; Galbraith, G. H., Guo & McLean 2000; Galbraith, G.H., Kelly & McLean 2004; Galbraith, G. H. et al. 1998; Glass 2007; Hedenblad 1996; Li et al. 2006; Segerholm 2007; Siau 1985).

The proposed method and experimental procedure described in this section is described in Paper IX, which is in turn based on Arfvidsson (1990), Arfvidsson and Cunningham (2000) and Segerholm (2007).

4.3.1 Non-Isothermal Moisture Transport Measurements

The new method of determining non-isothermal moisture flow coefficients is similar to the above method for isothermal moisture flow. A sample of wood is insulated and sealed on all but one side so the heat and moisture flow is one-dimensional. The RH of the surrounding humid air is changed in steps, and the sample is weighed continuously to determine the moisture uptake (or loss) over time. The difference from the isothermal method is that the sample is exposed to a constant temperature gradient by applying a heating pad at the inner side. The electrical heating is adjusted so that a constant temperature difference is maintained over the sample (for example 20°C at the open side against the humid air and 30°C at the inner side).

As mentioned before, the measurements for the isothermal and non-isothermal coefficients are done in different experimental set-ups. The isothermal moisture transport data was determined with the DVS 1000 and DVS Advantage using the methods presented in Arfvidsson (1990) and Anderberg & Wadsö (2005). Using this data, moisture transport coefficients can be found for each level of relative humidity at the current temperature. One phenomenon not investigated here is hysteresis, which is avoided by ensuring pure absorption or desorption.

The non-isothermal moisture transport data is gathered using a modified weighing method, which is explained in more detail in Paper IX. The sample is conditioned to a predetermined moisture level and sealed so that drying and moistening occur in one direction. A temperature gradient is applied to the sample and the change in mass (moisture flow) over time is recorded for this temperature gradient and relative humidity in the climate box. After the

sample is at steady state, the humidity is changed by changing the salt solution in the climate box, and the change in mass over time is measured again. This step is repeated in a sequence of steps in RH. The entire procedure is repeated for different temperature gradients in the sample.

This new method of measuring the non-isothermal moisture flow coefficient is based upon the idea of drying or wetting a material by applying a temperature gradient over the sample. The experimental set-up involves two parts. The first part, shown in Figure 15, is an insulated sample holder with a heating pad. The sample holder is made of Styrofoam insulation, aluminium and the System Platon sealing tape, which does not absorb any significant amounts of moisture. The sealing tape was tested in the sorption balance and absorbed approximately 0.4 mg/5000 mg sample of sealant from 0 to 95% RH. The sample holder is connected to a regulator with a sensor that ensures that the temperature at the top of the sample remains relatively constant, within $\pm 0.1^{\circ}\text{C}$ of the set temperature. This sample holder system is hung from a balance down into the climate box, Figure 16. A sample, which is sealed on all but one side, is inserted into the sample holder.

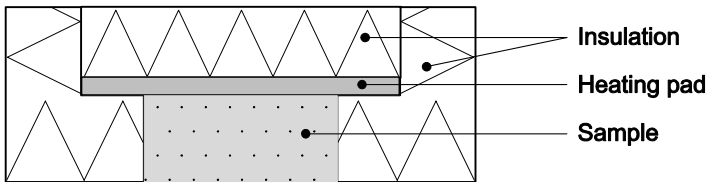

Figure 15: Cross section of sample holder.

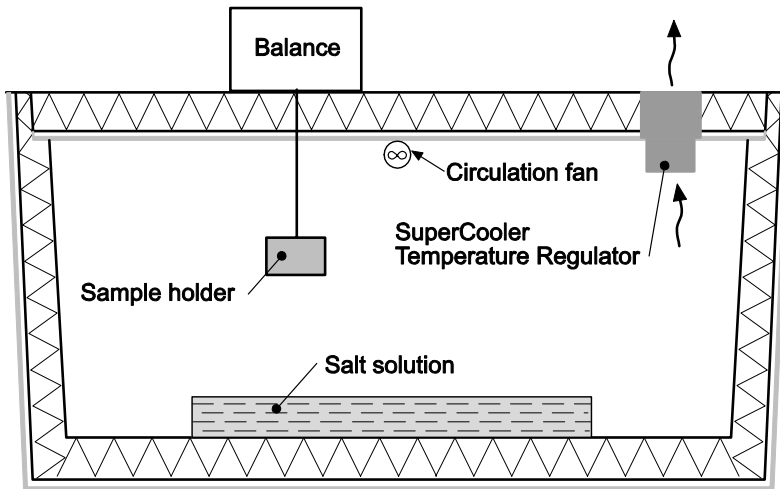

Figure 16: Section of the experimental apparatus with the sample holder hanging freely from a balance within the climate box.

The second part is an insulated climate box (Figure 16), which has a saturated salt solution at the bottom of the box, a circulation fan at the top of the box and a Supercool AA-024 thermoelectric air to air system with a PR-59 temperature controller. The AA-024 has both cooling and heating capacity with an accuracy of $\pm 0.01^{\circ}\text{C}$. When the system is running, the temperature varies $\pm 0.02^{\circ}\text{C}$ from the set point. Figures 17 and 18 show photos of the two parts of the described setup.



Figure 17: The left image shows the sample holder with a sample in the centre. The right image shows the control units with the sample holder to the right.

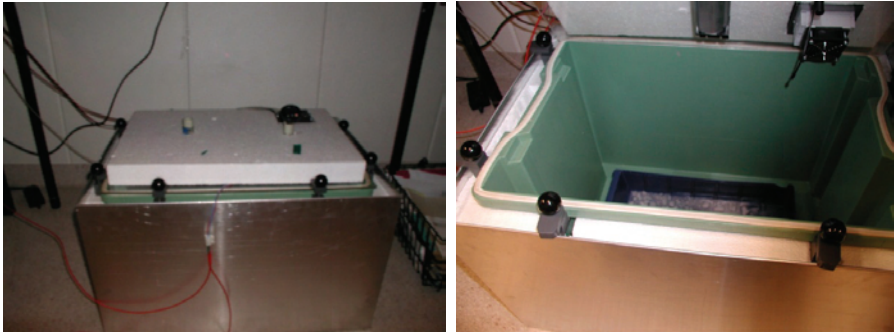

Figure 18: The insulated climate box with circulation fan, thermal regulator and salt solution.

The prototype was successful in providing data regarding the non-isothermal moisture transport in wood. However in order to increase the quality of the data and the reliability of the method, a second prototype must be built.

In the new version, the system needs to be developed so that the sample holder is not disturbed for the duration of the measurements. In the current prototype, the cover must be removed for about one minute for every moisture state change, exposing the sample to the indoor air. The cover is not easily re-sealed and the sample holder must be perfectly aligned under the balance before starting the next measurement run. The cover must sit tighter on the climate box.

If salt solutions are to be used, then it must be possible to remove them through a small door or hatch at the bottom of the box. The best means of controlling the humidity would be to connect a high performance humidity generator such as a Thunder 2500 humidity generator which has the advantage of changing humidity and temperature without interfering with the climate box.

The easiest problem to overcome is the problem of condensation in the climate box. The SuperCooler was dimensioned to handle the cooling load. However the surface area of the cooling fins is too small. The solution is to oversize the SuperCooler and install as much cooling surface area as possible. This should increase the minimum temperature in the climate box so that condensation does not occur at higher humidity levels. Unfortunately, the SuperCooler is not airtight. It has air leaks. While it has a foam border around the point of

insertion, there are holes in the cooling plate to allow for wiring. This was a large source of air/moisture leakage since the cooling fan forces air out of the climate box. Platon tape was used to completely seal the cooling fins.

The sample holder is currently connected by wire to a control box. It is unknown what kinds of errors occur because of this system. Ideally a new system should be developed to incorporate the heater control and power supply with wireless technology such as a laser-photovoltaic system so that the sample holder is completely free from any external objects.

The samples were prepared in the same way as in Chapter 4.2.2. The samples were cut from the same boards and dried in the same way in an oven at 105°C until there is no change in mass. The samples were sealed on three sides with Platon tape and a layer of parafilm leaving one side of the sample exposed to the conditioned air. The size and mass of the samples are shown in Table 4. Measurements are currently being conducted on the longitudinal moisture flow sample.

Table 4: Sample data for non-isothermal moisture transport.

Sample	Dry mass	Thickness	Diameter
Longitudinal flow	5.203 g	17.12 mm	27.37 mm
Radial Flow	4.4869 g	16.54 mm	27.37 mm
Tangential Flow	4.6440 g	16.52 mm	27.37 mm

4.3.2 Results of Measurements with the Prototype

Initial results (as seen in Figure 19 and Appendix III) show that this method can give the needed data to verify the mathematical model currently being developed. The next step is to improve this method based on the previous section so that reliable data can be acquired and applied to the theoretical model for validation.

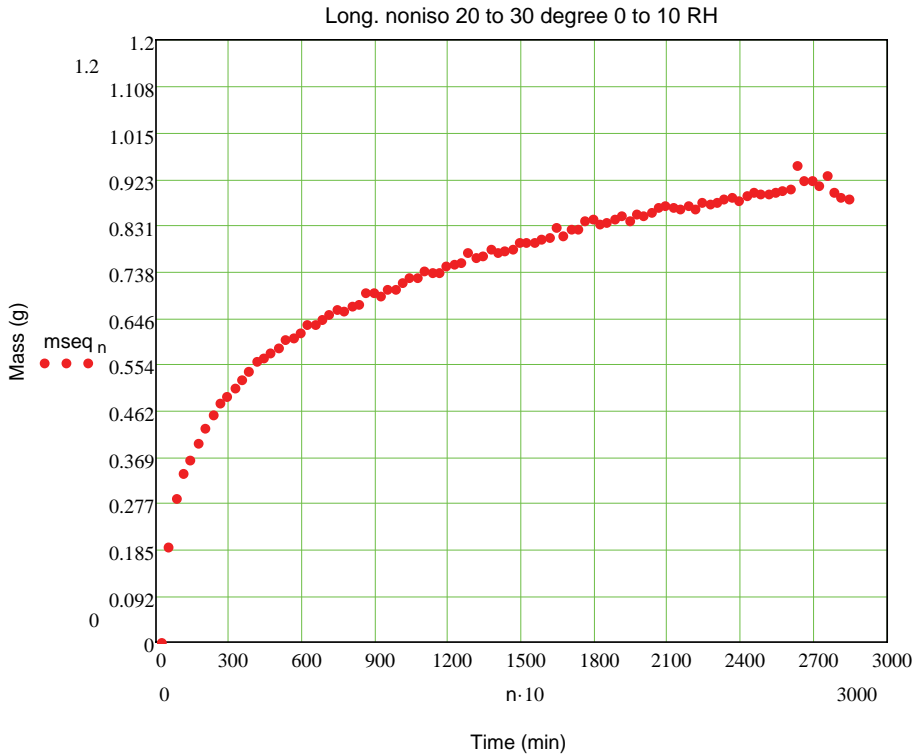

Figure 19: Results using the method developed above to measure non-isothermal moisture transport in wood.

4.3.3 Proposed Evaluation of Non-Isothermal Measurements

The evaluation to determine non-isothermal moisture flow coefficients from the curves of Figure 19 and Appendix III is, as mentioned before, beyond the scope of this thesis. However, in the future the evaluations will be performed along the following lines. The moisture uptake of Figure 19 depends on the transient flow process in the sample, the constant temperature gradient, the initial conditions and the boundary conditions. The moisture flow at any time and level of the sample consists of two parts. The first part involves the gradient in moisture state multiplied by the isothermal diffusion coefficient, which is known from the isothermal measurements for the temperature at the considered level. The second part involves the known temperature gradient

multiplied by the non- isothermal diffusion coefficient, which is to be determined. The idea is to solve the moisture flow process numerically for different values of the unknown non- isothermal coefficient and choose the value that gives the best fit to the measured moisture uptake curve.

5 Discussion and Conclusion

Building physics is an important area of science in the building industry. It encompasses heat, air and moisture flows in building components. This translates into energy issues, health of the occupants, and durability of materials. Improper understanding of building physics principles can lead to buildings which do not meet design criteria. Failure in this case is when the building does not perform as designed from a physical and economic standpoint. Again and again we see that these failures are still occurring despite all the advances in technology. These failures are usually expensive to repair and they usually could have been prevented during the design phase of the building process for little to no extra cost.

This thesis gives some insight into how these failures keep occurring. It is a complex combination of legislation, warranty system, worker skills, consultant tools, use of these tools, their level and age of consultant education, their level of experience and most importantly how much feedback they receive regarding their past projects. All of these factors play a role into the risk of failure thus emphasizing the need for a holistic approach. As buildings become more energy efficient they are also becoming more sensitive to mistakes. This means that as the building codes get tougher the demands on the engineers are increased.

People sometimes state that ‘it was better in the past’. Then they present examples of old buildings which are still standing. Almost all of these examples are in their original or only slightly modified design. They usually have a lot of air leakage, no active ventilation system and use a lot of energy to heat. They are not able to meet the design criteria for thermal comfort in new buildings. The key to why they have lasted so long is that they do not have much insulation and this energy flow out of the building means that there is a good drying potential going through the building components in turn drying any moisture from the component. These same old buildings can be ruined within just a few years if they are upgraded incorrectly because the reduced energy flow cannot dry the moisture from the building component. It is very difficult to make an old building perform as well as a new building without risking the structure. A project of this type demands that the engineers have good knowledge in the field of building physics.

Building physics tools can help reduce the risks of these failures. A consultant can be given a tool to use for their job, but if they do not have proper training

or information on how to use it this can do more harm than good if the tool is used in a way in which it was not intended to be used. It is important to remember that tools should only be used to solve problems that they were designed to solve using correct material data. In many cases the lack of material data is a big problem which can mean that the tool cannot be used. All tools have limitations, and it is important that these limitations are observed.

As shown in both this thesis and in previous literature, engineers do not make use of many tools unless directed to. New tools generally make use of newer theories and material data. Better computers allow for much more complex tools to be developed. Unfortunately, this thesis indicates that most engineers in the field of moisture control do not operate in a good system. They make use of the knowledge gained during their education but do not get updated adequately. The economic system used by consultants does not see feedback and time for reflection as something which yields economic gain. Therefore most companies discourage this during working hours. In some other fields, such as medicine, reflection is essential and can cost people their lives if their Doctor misses something which was a recent discovery.

Perhaps one of the key factors preventing feedback is that moisture problems can take 10 years to develop and the home warranty only covers two to five years. This means that there is no economic incentive for the company to work hard to prevent this type of failure during the design phase. By the time the failure occurs, the client must pay for the repairs themselves. One example of this is from the housing exhibition, Bo01 in Malmö where a building owner must pay about four to six million Swedish kronor to repair moisture damage in a building that is only seven years old (Söderberg 2009). Unfortunately, many times the initial building owner is the builder who does not have many demands and plans on selling the building.

One of the most startling results from this thesis is the idea of confidence and ability with moisture issues. Engineers with a lot of experience can have a lot of confidence in their ability to handle moisture issues, when in reality they have a low ability and most advanced projects will have a high risk of failure. This means that the people who are the least competent to complete the project can be the best at convincing you that they will see it through with no problems.

Yverås (2009) showed that even highly educated people are prone to this behaviour if their education is old and they have not been in an adequate feedback loop during their career. Experience and level of education cannot be used as an indicator of a person's ability with moisture control without

knowing their past performance. The only possible way to determine this is to research the person's past projects and see if these have failed or not and look at what current education they have. This might be very difficult and time consuming since they have most likely not kept a record of this type of information themselves.

Building physics tools can help engineers with a low level of ability by allowing them to make use of the newest information, if the engineer is properly instructed on the use and limitations of the tool. The tools are not free of problems however. Unfortunately, many people think that if a computer program calculates a number this number must be the truth. Many engineers recognize when a number is unrealistic and can look through the input data to identify a mistake. However most programs are black-boxes and engineers can not usually see or control exactly how the program calculates. Most tools which calculate moisture use old models which are not physically correct. They must be tuned in order to agree with measured data by the use of constants. Some also use functions based on curve fitting data. Another problem is that the models and the data in them are 'tuned' to 20°C and do not handle real life situations with temperature gradients.

Moisture problems are complex. The material's properties must be known in regards to various temperatures and moisture states. WUFI (Kunzel et al. 2009), currently one of the best tools available for combined heat and moisture calculations for example, makes use of material data based on moisture state but not on temperature. WUFI must also use tuned functions so that the calculations agree more with measured data because the theoretical model in the program is based on old and accepted models and not based on a physical model.

Unfortunately it appears that the advancement of computers is not helping the advancement of physical models within the field of building physics, but only promoting the adaptation and modification of numerical models. More and more literature is based on computer simulations which use old numerical models which have been tuned to match measured results without understanding why the two did not match to begin with. The problem with this is that the tuned model is only valid for the current conditions and cannot handle situations which fall outside the parameters for which the model was tuned. This means you need an infinite number of modified models to solve an infinite number of problems. A purely physical model should be able to model the behaviour for an infinite number of scenarios without modifying the model. However history teaches us that there are always exceptions to the rule

but there are usually different rules for the exceptions. Research is needed to discover these new rules, such as in the case of using Fick's Law to describe moisture transport in wood.

An example of a more physically correct tool was developed for frost penetration under a slab-on-the-ground. The material data was temperature based and the energy absorbed or emitted (latent heat of fusion) was also taken into account. It was shown in this thesis that the results from the more physically correct model were different from the simpler model. Which is closer to reality is currently unknown since the program and model has not been validated. However if the more physically correct model is closer to reality then this could mean significant energy savings in northern climates due to a better optimisation of insulation under a foundation since the old models show frost penetration at lower depths.

The potential economic impact for more physically correct moisture simulation tools is much higher. As shown in the thesis, moisture problems are the cause of significant economic costs from both repairs and health of the occupants. In order to develop these types of models the basic principles behind moisture transport must be understood for both isothermal and non-isothermal moisture transport. This thesis showed a new method of measuring non-isothermal moisture transport in wood along with some preliminary measurements. This will be important in developing new models. This thesis also showed some preliminary results of isothermal moisture transport using a new two-level model which is based on the physical structure of the wood. More research is needed to develop both models to their full potential.

In conclusion, there is a huge economic and societal potential to be realised from the application of building physics tools in the building sector and the development of more physically correct tools. This needs to be done by people who are properly educated and managed so that they are aware of how to properly prevent moisture problems during the design and construction phases of the building process. Current management practises too often only look at future jobs and focus on bringing money into the company. Consultants are not allowed to spend time reviewing their past projects or updating themselves on the latest tools and information. This system negates real experience for the engineers. Moisture problems will keep occurring as long as this system is dominant regardless of the quality of tools available.

If this trend is to be broken, management must decide to incorporate feedback into the system in which the consultants operate and make experience a

valuable asset once again. The scientific community must play their part by delivering advanced tools that are easy and economical for the consultants to use.

6 References

Anderberg, A & Wadsö, L 2005, 'Method for simultaneous determination of sorption isotherms and diffusivity of cement based materials', paper presented to Proceedings of the 7th Symposium on Building Physics in the Nordic Countries, Reykjavik, Iceland.

Anticimex 2004, *Fukt- och mögelskadad krypgrund - Ett faktum för 170 000 svenska villaägare (Moisture and mould damaged crawl spaces - A fact for 175 000 Swedish single family home owners, Swedish)*, viewed March 22nd, 2005.

Apte, MG, Fisk, WJ & Daisey, JM 2000, 'Associations between indoor CO₂ concentrations and sick building syndrome symptoms in U.S. office buildings: an analysis of the 1994-1996 BASE study data', *Indoor Air*, vol. 10, pp. 246-57.

Arfvidsson, J 1989, *Computer Model for Two-dimensional Moisture Transport. Manual for JAM-2*, Dept. of Building Technology, Lund.

— 1990, 'PC-MODELS FOR COMBINED HEAT AND MOISTURE FLOW IN BUILDING MATERIALS - Basic flow equations and required measurements', in JV Thue (ed.), *Building Physics in the Nordic Countries*, Trondheim.

Arfvidsson, J & Cunningham, M 2000, 'A transient technique for determining diffusion coefficients in hygroscopic materials', *Building and Environment*, vol. 35, pp. 239-49.

Arfvidsson, J, Hagentoft, C-E & Samuelson, I 2005, 'How do we implement building physics knowledge to the building sector?' paper presented to The 7th symposium on Building Physics in the Nordic Countries, Iceland.

Arfvidsson, J & Sikander, E 2002, *Fuktsäkert byggande - Enkätstudie om kunskapsläget (Moisture-safe building - Survey of the level of knowledge)*, 0205, FOU-Väst, Göteborg.

Argyris, C, Putnam, R & Smith, D 1985, *Action science: Concepts, methods, and skills for research and intervention*, Jossey-Bass, San Francisco.

Augenbroe, G 2002, 'Trends in building simulation', *Building and Environment*, vol. 37, pp. 891-902.

Avramidis, S & Siau, JF 1987, 'Experiments in nonisothermal diffusion of moisture in wood', *Wood Science and Technology*, vol. 21, pp. 329-34.

Avramidis, S & Wu, H 2006, 'Artificial neural network and mathematical modeling comparative analysis of nonisothermal diffusion of moisture in wood', *Holz als Roh- und Werkstoff*, vol. DOI 10.1007/s00107-0.

Bagge, H 2007, 'Energy Use in Multi-family Dwellings: Measurements and Methods of Analysis', Licenciate Thesis thesis, Licenciate in Engineering thesis, Lund University.

Barrett, D 1998, *The Renewal of Trust in Residential Construction*, Government of the Province of British Columbia, viewed May 17 2009, <<http://www.hpo.bc.ca/Publications/Barrett1/>>.

Barrett, P & Stanley, C 1999, *Better construction briefing*, Blackwell Science Ltd., Oxford.

Becker, R 1999, 'Research and development needs for better implementation of the performance concept in building', *Automation in Construction*, vol. 8, pp. 525-32.

Bellia, L 2003, 'A simple evaluator of building envelope moisture condensation according to an European Standard', *Building and Environment*, vol. 38, pp. 457-68.

Blanton, H, Carvallo, M, DeHart, T & Pelham, BW 2001, 'Overconfidence as Dissonance Reduction', *Journal of Experimental Social Psychology*, vol. 37, pp. 373-85.

Blomberg, T 1996, 'Heat conduction in two and three dimensions - computer modelling of building physics applications', PhD thesis, Lund University.

Bogoslovskii, VN 1965, 'The Moisture Potential', *Inzhenerno-Fizicheskii Zhurnal*, vol. 8, no. 2, pp. 216-22.

Boyer, H, Garde, F, Gatina, JC & Brau, J 1998, 'A multimodel approach to building thermal simulation for design and research purposes', *Energy and Buildings*, vol. 28, pp. 71-8.

Brinck, Y 2007, 'Fuktskador i putsade träregelväggar (Moisture damages in rendered wood-framed walls, in Swedish)', *Bygginfo PM*, vol. 31, no. 2, pp. 44-5.

Brugge, D, Vallarino, J, Ascolillo, L, Osgood, ND, Steinbach, S & Spengler, J 2003, 'Comparison of multiple environmental factors for asthmatic children in public housing', *Indoor Air*, vol. 13, pp. 18-27.

Byggindustrier, S 2003, *Fakta om byggandet (Facts about construction, in Swedish)*, Stockholm.

Byggtjänst, S *Enorm 1000, Manual (in Swedish)*, Svensk Byggtjänst, Stockholm, Sweden.

Carmeliet, J & Roels, S 2001, 'Determination of the Isothermal Moisture Transport Properties of Porous Building Materials', *Journal of Thermal Envelops and Building Science*, vol. 24, no. January 2001, pp. 183-209.

CMHC 2001, *Research Highlights: 2001 Building failures study*, September 25, 2003, <<http://www.cmhc.ca/publications/en/rh-pr/tech/01-140-E.htm>>.

Cox, P & Boel, M 2002, *Directive 2002/91/EC of the European Parliament and of the Council of 16 December 2002 on the energy performance of buildings*, European Union, Official Journal of the European Communities, <<http://eur-lex.europa.eu/LexUriServ/LexUriServ.do?uri=OJ:L:2003:001:0065:0071:EN:PDF>>.

De Vries, DA 1987, 'The theory of heat and moisture transfer in porous media revisited', *Int. J. Heat Mass Transfer*, vol. 30, no. 7, pp. 1343-50.

Deming, WE 1986, *Out of the crises*, Cambridge University Press.

Ebbehøj, NE, Hansen, MØ, Sigsgaard, T & Larsen, L 2002, 'Building-related symptoms and molds: a two-step intervention study', *Indoor Air*, vol. 12, pp. 273-7.

Ellis, MW & Mathews, EH 2001, 'A new simplified thermal design tool for architects', *Building and Environment*, vol. 36, no. 9, pp. 1009-21.

Engdahl, F 1998, 'Evaluation of Swedish ventilation systems', *Building and Environment*, vol. 33, no. 4, pp. 197-200.

Fang, L, Wyon, D, Clausen, G & Fanger, PO 2004, 'Impact of indoor air temperature and humidity in an office on perceived air quality, SBS symptoms and performance', *Indoor Air*, vol. 14, pp. 74-81.

Fick, A 1855, 'Ueber Diffusion', *Ann. Phys. Chem.*, no. 94, pp. 59-86.

Fisk, WJ 2000, 'Review of health and productivity gains from better IEQ (Indoor Environmental Quality)', in Helsinki, vol. 4, pp. 23-34.

Forrester, JW 1961, *Industrial Dynamics*, MIT press, Boston.

Galbraith, GH, Guo, JS & McLean, RC 2000, 'The effect of temperature on the moisture permeability of building materials', *Building Research and Information*, vol. 28, no. 4, pp. 245-59.

Galbraith, GH, Kelly, DJ & McLean, RC 2004, 'Moisture permeability measurements under reduced barometric pressures ', *Materials and Structures*, vol. 37, no. June 2004, pp. 311-7.

Galbraith, GH, McLean, RC, Gillespie, I, Guo, J & Kelly, D 1998, 'Nonisothermal moisture diffusion in porous building materials', *Building Research and Information*, vol. 26, no. 6, pp. 330-9.

GEO-SLOPE 2008, *Thermal Analysis with TEMP/W*, GEO-SLOPE International Ltd., viewed August 4, 2008.

Glass, SV 2007, 'Measurements of Moisture Transport in Wood-Based Materials under Isothermal and Nonisothermal Conditions', paper presented to Buildings X, Florida, USA.

Globus, AM & Nerpin, SV 1966, 'NONISOTHERMAL MOISTURE TRANSFER IN CLOSED DISPERSE SYSTEMS', *Inzhenerno-Fizicheskii Zhurnal*, vol. 11, no. 4, pp. 487-94.

Goodings, DJ & Ketcham, SA 2001, 'Research versus practice in transportation geotechnics: Can we bridge the chasm?' *Journal of Professional Issues in Engineering Education and Practice*, vol. 127, no. 1, pp. 26-31.

Hedenblad, G 1996, 'Moisture permeability of some porous building materials', in *Building Physics in the Nordic Countries*, Espoo, Finland, vol. 2/96, pp. 747-54.

Heylighen, A, Neuckermans, H, Casaer, M & Dewulf, GPM 2007, 'Building Memories', *Building Research and Information*, vol. 35, no. 1, pp. 90-100.

Hien, WN, Pho, LK & Feriadi, H 2000, 'The use of performance-based simulation tools for building design and evaluation - a Singapore perspective', *Building and Environment*, vol. 35, pp. 709-36.

Hägerhed-Engman, L 2006, 'Indoor Environmental Factors and its Associations with Asthma and Allergy Among Swedish Pre-School Children', PhD Thesis thesis, PhD thesis, Lund University.

Industries, soSE 2001, *LCC-based guidelines on procurement of energy intensive equipment in industries*, SAVE contract.

Jansson, A, Samuelson, I & Mjörnell, K 2007, 'Skador i putsade träregelväggar (Damages in rendered wood-framed walls, in Swedish)', *Bygg & teknik (Buildings and Technology)*, no. 1.

Jelvefors, A 2002, 'Lägenheter vattenskadade på Bo01 (Waterdamaged apartment at Bo01)', *Metro*, 2002-03-19.

Johansson, D 2002, 'Modelling LCC for different indoor climate systems', Licenciate thesis, Lund Institute of Technology.

— 2005, 'Modelling Life Cycle Cost for Indoor Climate Systems', PhD Thesis thesis, PhD thesis, Lund Institute of Technology.

Josephson, PE & Hammarlund, Y 1999, 'The causes and costs of defects in construction: A study of seven building projects', *Automation in Construction*, vol. 8, pp. 681-7.

Jyske, T, Mäkinen, H & Saranpää, P 2008, 'Wood density within Norway spruce stems', *Silva Fennica*, vol. 42, no. 3, pp. 439-55.

Kolb, D 1984, *Experiential learning: experience as the source of learning and development*, Prentice Hall, New Jersey.

Kunzel, H, Kehrer, M, Schmidt, T, Eitner, V, Zirkelbach, D & Pankratz, F 2009, *WUFI Pro 4.2 PC software tool for one-dimensional hygrothermal building envelope simulation*, Fraunhofer Institute for Building Physics, Holzkirchen.

Kåberger, T & Hammes, K 2008, *Energy supply in Sweden (In Swedish)*, Eskilstuna.

Landin, A 2000, 'Impact of quality management in the Swedish construction process', PhD Thesis thesis, Lund University.

Larsson, S 2008, 'Mögelskandalen kostar miljarder (Mould scandal costs billions, in Swedish)', *E24*, viewed May 16, 2008, <http://www.e24.se/bransch/astighetbygg/artikel_435333.e24>.

Lazaruk, S 2006, 'Leaky Condo's in BC, Search still on for leak-proof wall', *The Vancouver Province*, no. August 6, 2006, viewed 2009-04-17, <<http://www.lestwarog.com/newsArticle-2468.html>>.

Li, X, Zhang, B, Li, W & Li, Y 2006, 'Nonisothermal moisture movement in wood', *Front. For. China*, no. 3, pp. 348-52.

Luthander, P 2001, 'Skanskas bygglarv orsakade mögel (Skanska's construction carelessness caused mould)', *Dagens Nyheter*, 2001-02-13.

Nelson, RM 1986, 'Diffusion of bound water in wood', *Wood Science and Technology*, vol. 20, pp. 309-28.

— 1991, 'Test of an equation for nonisothermal moisture transport in wood', *Wood Science and Technology*, vol. 25, pp. 312-25.

Parikh, J & Biswas, H 2002, 'Economic burden of respiratory illness in rural Uttar Pradesh, India', in Monterey, USA, pp. 1018-23.

Persson, M 1999, 'Ny byggprocess - Svedalamodellen (New building process - The Svedala model)', Lund University.

— 2006, 'Lessons Learned in Knowledge Management - the case of construction', PhD thesis, Lund University.

Peterson, DK & Pitz, GF 1988, 'Confidence, uncertainty and the use of information', *Journal of Experimental Psychology: Learning, Memory and Cognition*, vol. 14, pp. 85-92.

Peuhkuri, R 2003, 'Moisture Dynamics in Building Envelopes', Ph.D. Thesis thesis, Technical University of Denmark.

Philip, JR & De Vries, DA 1957, 'Moisture Movement in Porous Material under Temperature Gradients', *Transactions, American Geophysical Union*, vol. 38, no. 2.

Roots, P & Hagentoft, C-E 2005, 'Frost Heave in Swedish Slab on Ground Foundations', paper presented to Proceedings of the 7th symposium on Building Physics in the Nordic Countries, Reykjavik, Iceland.

Samuelson, I, Mjörnell, K & Jansson, A 2007, *Fuktskador i putsade, odränerade träregelväggar - lägesrapport oktober 2007 (Moisture damages in rendered, undrained wood framed walls - progress report October 2007, in Swedish)*, 2007:36, SP Technical Research Institute of Sweden, Borås.

Samuelson, I & Nielsen, A 2002, 'Checklists for clean and moisture safe buildings', in A Gustavsen & JV Thue (eds), Trondheim, Norway, vol. 2, pp. 799-806.

Sandén, K 2007, 'Nybyggda villio svårt fuktskadade (Newly built single family dwellings badly moisture damaged)', *Sydsvenskan*, 2007-09-02.

Segerholm, I 2007, 'Moisture Transport Processes in Scots Pine - Anomalous Capillary Suction. Nonisothermal diffusion.' PhD thesis, Chalmers.

Seppänen, O & Fisk, WJ 2002, 'Association of ventilation system type with SBS symptoms in office workers', *Indoor Air*, vol. 12, pp. 98-112.

Siau, JF 1983a, 'Chemical Potential as a Driving Force for Nonisothermal Moisture Movement in Wood', *Wood Science and Technology*, vol. 17, pp. 101-5.

— 1983b, 'A Proposed Theory for Nonisothermal Unsteady-State Transport of Moisture in Wood', *Wood Science and Technology*, vol. 17, pp. 75-7.

— 1985, 'Nonisothermal moisture diffusion experiments analyzed by four alternative equations', *Wood Science and Technology*, vol. 19, pp. 151-7.

Siau, JF, eene & Avramidis, S 1993, 'Application of a thermodynamic model to experiments on nonisothermal diffusion of moisture in wood', *Wood Science and Technology*, vol. 27, pp. 131-6.

SINTEF 2007, *Building and Infrastructure*, viewed July 9th, 2008, <<http://www.sintef.no/content/page2.aspx?id=16592>>.

Skaar, C & Siau, JF 1981, 'Thermal Diffusion of Bound Water in Wood', *Wood Science and Technology*, vol. 15, pp. 105-12.

Strumillo, C, Grinchik, PS, Kuts, PS, Akulich, PV & Zbicinski, L 1994, 'NUMERICAL MODELING OF NONISOTHERMAL MOISTURE TRANSFER IN BIOLOGICAL COLLOIDAL POROUS MATERIALS', *Journal of Engineering Physics and Thermophysics*, vol. 66, no. 2, pp. 181-91.

Sundell, J 2000, 'Building related factors and health', in vol. 1, pp. 23-33.

Sunding, L 2006, 'Gemensamt problemlösande och värdeskapande i byggprojekt (Common problem solving and value creation in building projects, in Swedish)', Licentiate Thesis thesis, Licentiate in Engineering thesis, Lund University.

Svennberg, K & Segerholm, I 2006, 'Performance of edge sealing systems', in P Fazio, H Ge, J Rao & G Desmarais (eds), *Research in Building Physics and Building Engineering*, Montreal, Canada, pp. pp 193-9.

Svensson, C 1999, *Utvärdering av Småhusskadenämndens arkiv avseende kryppgrunder - Genomgång av arkivet*, TVBH-3035, Avdelningen för byggnadsfysik, LTH, Lund.

Söderberg, A 2009, 'Moisture problem for millions (in Swedish)', *Byggvärlden*, April 28, 2009.

Tanish, A 1986, 'The roles of bound water chemical potential and gas phase diffusion in moisture transport through wood', *Wood Science and Technology*, vol. 19, pp. 53-70.

Taylor, SJ & Bogdan, R 1998, *Introduction to Qualitative Research Methods - A Guidebook and Resource*, 3rd edn, John Wiley & Sons, Inc., New York.

Thörn, Å 1999, 'The emergence and preservation of sick building syndrome - research challenges of a modern age disease', PhD Thesis thesis, Karolinska Institute.

Tolstoy, N 1994, *The condition of buildings. Investigation methodology and applications*, TRITA-BYMA, Royal Institute of Technology, Stockholm.

Wadsö, L 1993, 'Studies of Water Vapour Transport and Sorption in Wood', PhD thesis, Lund University.

Wardhana, K & Hadipriono, FC 2003, 'Study of recent building failures in the United States', *Journal of Performance of Constructed Facilities*, no. August, pp. 151-8.

Wargocki, P, Wyon, DP, Sundell, J, Clausen, G & Fanger, PO 2000, 'The effects of outdoor air supply rate in an office on perceived air quality, sick building syndrome (SBS) symptoms and productivity', *Indoor Air*, vol. 10, pp. 222-36.

Weiss, KB & Sullivan, SD 2001, 'The health economics of asthma and rhinitis: assessing the economic impact', *J. Allergy Clin. Immunol*, vol. 107, pp. 3-8.

Vik, TA 2003, 'Life cycle cost assessment of natural ventilation systems', PhD Thesis thesis, NTNU Trondheim.

Willers, S, Andersson, S, Andersson, R, Grantén, J, Sverdrup, C & Rosell, L 1996, 'Sick building syndrome symptoms among the staff in schools and kindergartens: are the levels of volatile organic compounds and carbon dioxide responsible?' *Indoor Built Environment*, vol. 5, pp. 232-5.

VIP+ 1996, *Computer program for energy balance calculations*, Skanska IT-Solutions, Solna, Sweden.

Yverås, V 2009, 'Competitiveness of a performance prediction method based on artificial intelligence', *To be submitted*.

Zillig, W 2009, 'Moisture transport in wood using a multiscale approach', PhD thesis, Katholieke Universiteit Leuven.

Öberg, M 2002, 'Application of integrated life cycle design on concrete residential buildings', in TD Pettersen (ed.), Oslo, Norway, pp. Paper 57-.

7 Appendix I – Appended Papers

- Paper I. Burke, S. (2003). Reducing the Risk of Failure in Performance within Buildings. In. ed. Atkin, B., Borgbrant, J., & Josephson, P-E., *Construction Process Improvement*, Oxford: Blackwell Science
- Paper II. Burke, S., Johansson, D. & Öberg, M. (2002) Decreasing a Buildings Operational Energy Costs through the Application of Building Physics Principles During the Design Phase. *Sustainable Building Conference*. Oslo, Norway.
- Paper III. Burke, S. (2003) The renovation costs of crawlspaces due to moisture damage. IN HANSSON, B. & LANDIN, A. (Eds.) *Construction Economics and Organisation - Proceedings of the 3rd Nordic Conference on Construction Economics and Organization*. Lund, Sweden, Division of Construction Management.
- Paper IV. Burke, S. (2007). Crawl spaces in wood framed single family dwellings in Sweden: unwanted yet popular. *Structural Survey* 25(1), p. 51-60
- Paper V. Wihlborg, C. & Burke, S. (2006) Decreasing the risk of moisture damage to prefabricated building components - from production to construction. *Research in Building Physics and Building Engineering*. Montreal, Canada, Taylor & Francis Group.
- Paper VI. Burke, S. & Yverås, V. (2004). A Swedish Perspective on the Prevention of Moisture Problems During the Building's Design Phase, *Nordic Journal of Surveying and Real Estate Research* 1(1), p. 102-113
- Paper VII. Burke, S. (2009). Confident or cautious moisture consultant – which is best, *Submitted to Building Research and Information*
- Paper VIII. Burke, S., Arfvidsson, J., Claesson, J., (2009) A New Algorithm to Calculate Frost Penetration under a Building during Periodic Variable Conditions, To be Submitted to: *Journal of Building Physics*
- Paper IX. Burke, S., Claesson, J. & Arfvidsson, J. (2008) A New Method of Determining Moisture Flow Coefficients for both Isothermal and Non-isothermal Conditions. IN RODE, C. (Ed. *Proceedings of the 8th Symposium for Building Physics in the Nordic Countries*. Kgs.

Lyngby, Denmark, Dept. of Civil Engineering, Technical University
of Denmark.

7.1 Paper I

Burke, S. (2003). Reducing the Risk of Failure in Performance within Buildings. In. ed. Atkin, B., Borgbrant, J., & Josephson, P-E., *Construction Process Improvement*, Oxford: Blackwell Science

Reducing the Risk of Failure in Performance within Buildings

Stephen Burke

Introduction

Building failures occur daily because of misunderstandings over the importance of building physics, especially among the different actors in the construction process, each of whom may have a different appreciation of causes and effects. Legislation, which has been passed to ensure the health and safety of the occupants, has addressed some of the larger performance issues such as thermal comfort, energy usage and, to some extent, indoor air quality. However, other types of building failure continue to be ignored. These are the longer-term soft issues such as high moisture content in a building, high-energy costs and the overall sustainability of the building.

These types of building failures are believed to be linked to health problems and are largely preventable with today's knowledge of building physics. This chapter looks at current building failures directly attributable to the neglect of building physics principles, and why it is important to include these factors actively in design decision-making.

State-of-the-art review

Building physics is comprised of many various components. This section will look at these components, the role that economics plays and the effects that building failures have on people's health.

Building physics

Building physics is the science of how matter and energy interact within a building system. More specifically, this field encompasses the areas of heat, air (ventilation), moisture flows and the energy interactions between all of them.

It is important to note that the Swedish context of building physics does not include acoustics and fire protection as in other countries (Sandin 1990). This area of science exists to ensure that people have an area to live in that provides thermal comfort and does not cause health problems. Many health issues arise when fundamental physical principles are overlooked or ignored and this can translate into higher costs for society as a whole.

The literature related to economic aspects of building physics is negligible. Jóhannesson & Levin (1998) attempted to examine these two areas concurrently in their paper by looking at the relationship between design that neglects common theories of building physics and the consequent environmental and economic cost. In their paper, a typical Swedish single-family dwelling was examined under two scenarios: one without any special environmentally friendly materials or features, and the other incorporating materials that are considered to be environmentally friendly by

current standards. The authors focused on the performance of available environmentally superior materials when considered in a life cycle cost (LCC) context and found many to be inferior. Using more environmentally friendly materials did yield lower energy use and costs for construction. Over the operational life, the difference in performance between the two buildings was great enough for the environmentally friendlier building to be more energy-intensive over its life than the standard building. The weakness in this paper, as declared by the authors, is that it does not look at the economic repercussions of either including or excluding building physics issues in themselves; but it is able to give an idea of the result of ignoring building physics principles.

It appears that most of the literature that is related to building physics looks at building physics in its various components and does not bring economic factors into view. The literature generally considers potential problems that a building can have from a health perspective and tries to attribute the problem to one or two faulty components in the building and their possible remedy.

Heat flows

Heat flow principles are the backbone of modern, energy-efficient buildings. In order to make a building use less energy for heating and cooling, walls are insulated with materials that minimise the heat flow between the inside and outside of a building. Another benefit of an energy-efficient building is the level of thermal comfort that people feel in the building. People are very sensitive to temperature changes and even a small heat loss is detectable. Thermal comfort is not, however, determined by temperature difference alone; moisture levels and air pressure can also have an effect on people's thermal comfort.

With energy-efficient buildings come new problems in the areas of moisture and ventilation. While heat flows are in themselves largely understood, the repercussions of energy-efficient buildings on moisture levels and health are not. As a building's energy efficiency increases, so does its potential for moisture and ventilation problems if it is not designed properly (Thörn 1999). The design, construction, materials and workmanship of the smaller components of a building become more important and can make a significant difference in building performance. For example, reducing the thermal bridging in a typical Canadian timber-framed wall by applying an exterior insulated sheathing yields a 12% gain in efficiency (Ministry of Housing 1990).

Europe is currently trying to find a way of encouraging people to build more energy-efficient homes. One means of accomplishing this is by creating an 'energy certification ...[offering] advice for new and existing buildings and a public display of certificates in certain cases' (ECCP 2001).

In addition to this, new and newly renovated buildings will have to meet a minimum standard of energy performance, and this will be measured by a standardised measuring system. This should force designers and construction companies to increase their level of performance, resulting in higher quality buildings than we have today.

The United States has also initiated a similar programme called High-Performance Commercial Buildings: A Technology Roadmap. 'The fundamental goal is to optimise the building's performance in terms of comfort, functionality, energy efficiency, resource efficiency, economic return, and life-cycle value' (Swartz 2001).

This plan will be executed over the next 20 years and will involve the US Department of Energy (DOE) and its partners in both the public and private sectors.

It is becoming more common today for researchers to combine heat and moisture flows in their research areas and attempt to answer the questions of what effects heat flows in buildings have on moisture flows and ventilation requirements (Samuelson 1998). The theory behind moisture and heat flows are very similar, but there is one important factor that makes moisture calculations much more complex than heat flows. The difference is that when heat flows are calculated, the materials are assumed to be dry and the effects of thermal conductivity are negligible. Calculations are therefore based on a constant temperature and moisture state. Yet, moisture properties are very sensitive to changes in both temperature (the vapour permeability is temperature dependent) and moisture state. One cannot assume a constant temperature or moisture state when calculating moisture flows. In addition, other factors such as the material's properties and air velocity can have effects on the flows. A careful balancing act is required to obtain buildings that are both energy-efficient and healthy for its occupants (Sandin 1990).

Computer software is available for calculating heat flows in buildings. Most of these are specific programs designed to calculate the heat flows of various components like attics, crawl spaces and walls. Some of the software such as *MOIST*, *HEAT2* and *HEAT3* look at the one, two and three-dimensional steady state of a design respectively. The user is able to improve the heat resistance of the design by changing both the design and materials used in the simulation in order to decrease the amount of heat energy lost from the building. The main concern with current software that is available today is that it is difficult to use (Blomberg 2000; Burch & Chi 1997).

There are also many computer programs available for calculating the energy usage of a building. These programs usually take into account the weather, type of windows, type of walls, and other specific details of a building. Each program usually has a feature that sets it apart from others. For example, *ENERGY-10* can include passive solar heating, glazing and thermal mass in the design phase (*EREC* 2000). *NHER Evaluator* also calculates energy usage; however, it has the option of calculating surface condensation and the effects of cold snaps (*NES* 2000). Using software of this sort enables users to test alternative materials and designs in order to optimise their building's energy usage.

Air flows

Ventilation is the link between the indoor air and outdoor air of a building. With proper ventilation, a building has a readily available supply of fresh air that keeps the interior thermal environment comfortable and moisture levels under control. As buildings become more energy-efficient, they are required to be more airtight. This places more importance on a properly designed and balanced ventilation system. Without properly designed ventilation systems, buildings can rapidly become odorous and unhealthy to the occupants, because of a build-up of chemicals, moisture and organic compounds. In recent years there have been many studies looking at the relationship between indoor air quality and ventilation rates. The consensus is that, up to a certain point, the lower the ventilation rate, the worse the indoor air quality (Fisk 2000; Sundell 2000; Wargoeki *et al.* 2000; Apte *et al.* 2000; Milton *et al.* 2000). For a more detailed examination of the importance of ventilation systems, see Chapter 5 (*A life cycle cost approach to optimising in door climate systems*).

Moisture flows

Moisture and its effects on a building is a common topic of discussion within the building physics field today (Luthander 2001; Samuelsson 2001). The topic is, however, very complex and covers many areas of science.

If we want to understand fully the problems caused by moisture we must look to various disciplines in the scientific community. They include medical doctors and researchers, microbiologists, biologists, physicists, chemists and engineers. By taking a multidisciplinary approach, we can begin to understand the nature of the problems associated with moisture in buildings and how to prevent them (Wolkoff *et al.* 1997; Sundell 2000).

Three methods of transportation that enable moisture to come into contact with materials are convection, diffusion and capillary action. Convection processes involve moving air that picks up and deposits moisture on the surface of materials. Diffusion of moisture through the air contributes less moisture to a material than convection, due to the volume of moist air that is exposed to the surface of the materials. Capillary action mostly takes place underground, when groundwater is drawn into the materials (Sundell 2000; Nevander & Elmarsson 1994).

There are many different paths for moisture to enter a building and these can appear during any of the different stages in the construction process. Before the construction phase, some of the materials can be shipped wet to the job site. For whatever reason, these materials are not allowed to dry properly or they are exposed to water in storage or during transportation. Even if materials are shipped dry, they sometimes become wet at the job site due to improper storage. If materials are stored properly, i.e. stored indoors or covered up, the risk of a building becoming damaged due to moisture can be significantly reduced (Sundell 2000; Nevander & Elmarsson 1994).

After the building is complete, there is still a risk of damage from both the indoor and outdoor environments. Figure 7.1 shows some of the possible damages that can occur when different materials are exposed to various levels of moisture. The majority of moisture damage begins once the relative humidity has reached a level of around 75%. This shows the importance of proper ventilation and indoor climate control. Indoors, people contribute to the moisture level by physically sweating, cooking food, taking showers etc. In other buildings such as paper mills, swimming pools, and other facilities that use a lot of water, there is a very high risk of moisture damage due to condensation (Sundell 2000; Nevander & Elmarsson 1994).

The greatest outdoor risk to a completed building is the weather. Rain, snow and humid air can result in exposed materials becoming very moist. In addition, leaks in the vapour barrier and in the roof can allow moisture to come into contact and contaminate various materials.

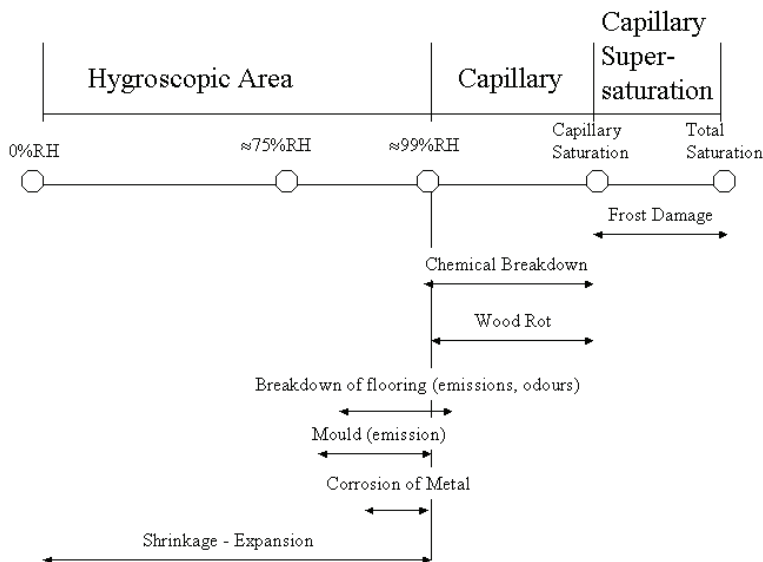

Fig. 7.1 The effects of Relative Humidity (RH) on different building components (based on ideas, contributed during a discussion, by Professor Göran Fagerlund, Lund Institute of Technology, Lund, Sweden).

Despite the availability of this knowledge, the same problems continue to occur. A recent, large-scale housing project (Hammarby Sjöstad in Stockholm) that was designed according to environmentally friendly principles became a focus for the mass media when moisture problems developed in some near finished apartments. The problem was attributed -though not proven -to an unusually moist summer during the on-site production phase. The materials were not protected adequately from the moisture and in turn became wet. Not long after the heating system was activated, mould began to grow on the materials, contaminating a number of the apartments (Luthander 2001). Problems of this nature are not limited to Sweden; Denmark, the UK and many other countries are seeing an increase in moisture-related problems. These projects illustrate that even well designed, environmentally friendly buildings can have moisture problems due to a combination of weather, materials and, increasingly, the on-site production process.

Computer programs that attempt to predict the likelihood of moisture penetration are increasing in number. However, they are few in comparison to heat modelling programs due to the complexity of moisture flow. In order to develop a reliable moisture model, an accurate temperature model must be used. Some software exists today: *WUFI* from Germany is able to calculate both heat and moisture flows in a one- or two-dimensional scale using different materials (Gertis 2000). *RISKI* from Sweden is a one-dimensional program that calculates the risk of moisture damage to a building depending on its geographic location (Harderup 1999); and *MOIST* from the US is a one-dimensional heat and moisture calculation program (Burch & Chi 1997).

Economic aspects

Failure in the performance of buildings results directly in financial loss for owners, occupants and other stakeholders each year. According to Fisk (2000), in the US, the estimated potential annual savings and productivity gains are US\$ 6-14 billion from reduced respiratory disease, US\$ 2-4 billion from reduced allergies and asthma, US\$10-30 billion from reduced sick building syndrome symptoms, and US\$ 20-160 billion from direct improvements in worker performance that are unrelated to health. In Sweden, about SEK 6 billion (€665 million) per year is spent on repairs and maintenance. Of that, roughly half goes to damages attributed to moisture damage (Tolstoy 1994).

Today, the average Swedish household can expect to pay SEK 200 000 - 300 000 (€22 000-33 000) to repair its moisture-damaged home. These costs do not include health care costs associated with asthma, multiple chemical sensitivity, sick building syndrome and reduced productivity, all of which can be caused by a building with poor performance. While it is debatable whether some of these illnesses can be attributed to physical or psychological causes, it remains the case that people suffer from symptoms caused by inadequate buildings (Willers *et al.* 1996; Wolkoff *et al.* 1997; Arnetz 1999; Terr 2000; Apte *et al.* 2000; Milton *et al.* 2000; Wargocki *et al.* 2000).

It is rare for construction companies -house builders in particular- to calculate and show their customers the long-term operating costs and likely problems associated with a specific design. Barrett & Stanley (1999) touch on the issue of customer empowerment, arguing that the construction sector should empower its customers and should enable them to become more acutely aware of the details of their project (or home). This could be interpreted as arguing the case for greater awareness on the part of customers. If customers are insufficiently experienced to address certain issues of the construction process, the sector should provide information to enable them to fulfil their role as informed (or intelligent) clients. This information could be in the form of possible and known design issues, estimated operating costs such as energy usage over the lifetime of the building, maintenance costs or the overall sustainability of the building (Barrett & Stanley 1999).

When a building is found to malfunction, the materials of its composition are among the first items to be investigated. The decision to use one material over another is usually more of an economic issue than one of performance. An exception to this is if a more expensive material is chosen for its environmental properties. However, this does not mean that the material is superior physically. Usually, greater emphasis is placed upon materials that are cheap and that will perform to the minimum performance required by legislation and building codes. This helps to keep the cost of the building down, which is an advantage to both the construction sector as well as the economy.

Recognising that the lowest bid does not always represent the most economically advantageous solution is a widely held view. Some countries have adopted other methods such as eliminating the highest and lowest bids and accepting the bid closest to the average (Hatush & Skitmore 1998). While this method can help to reduce short-term building failures by allowing companies with better quality control over workmanship to be awarded contracts, this does not guarantee that long-term building failures will be avoided. The operating costs of a high-quality building can still be high due to inadequate measures regarding energy use. However, companies

can reduce the risk of both short and long-term problems and energy costs by addressing aspects of building physics early in the construction process.

Research project

Project description and objectives

The aim of this project is to determine and develop tools that could be used to include aspects of building physics in the design stage of buildings, by highlighting some of the economic benefits. This project will entail the identification of building physics areas having the largest potential impact on the decision-making process, the design of a tools package for use in the sector, the testing of this package by companies and the analysis of results. The main objective of this project is complementary to other projects discussed in this book. The concept behind this particular project is that by improving the quality of new buildings, the construction sector will gain techniques and knowledge that will make it more competitive on both the national and international level.

Research methodology

This project makes use of qualitative and quantitative methods. In the early days of this project, a literature study was conducted in order to determine the areas where the building physics tools package would have the most beneficial impact on the construction sector. This will be continued during the entire project. A problem with literature surveys is that they do not indicate the kinds of tools the sector might be interested in deploying.

Interviews and surveys are methods of enquiry that could be used to help in defining such tools. These methods would be more reliable than a literature study; however, such methods can be problematic, not least because of the difficulty of establishing a representative sample. That said, it is recognised that commercial exploitation of the results of the research would most probably require sampling of the population.

Participant observation is an alternative method that could be used to record a construction company's activities and enable a tools package to be designed to fit those activities. However, this was not considered to be an appropriate method, because of the amount of time required to conduct observations.

Once a tool is designed and developed, a few methods are available for analysis and verification. The primary method under consideration is a detailed case study of one company to determine what effects the tool has had on the company's decision-making process when planning a building. An alternative is to use the tool with a number of different companies and create examples that are less detailed, but perhaps more representative of the construction sector than a single case study. A later phase in the research may, therefore, include a set of case studies in which specific experiences of using the tools package might be investigated.

Research results and industrial impact

Quantification of results

In this project, we expect to see that the cost of actively incorporating building physics principles into the design phase of a building is demonstrably less than the potential consequences of not including them. Up to now, the literature suggests that there are large potential cost savings from integrating building physics principles into design decision-making. The literature also suggests that these savings should come primarily from reduced renovation costs, increased energy efficiency of the building during occupation, increased performance from workers and decreased sick leave/health care costs.

Implementation and exploitation

Discussions will take place with related projects under *Competitive Building*, with a view to having the resultant tool utilised in practice -see also Chapter 6. The aim will be to help designers achieve greater energy efficiency and avoid, or at least reduce substantially, moisture problems. A tools package of this nature could also increase the competitiveness level of Swedish construction companies on both the national and international level.

The incentive for utilising the tools package in routine design is to cut ownership costs for the customer (and taxpayers) by reducing the amount of repairs arising from moisture problems and health problems associated with the occupation of buildings. If customers were made aware of the tools available to designers and construction companies, they might force their use through demands for better information. There is also the health dimension. Operatives who feel healthier are more productive; even a small increase in productivity can translate into worthwhile profits for a company. In addition, by ensuring a high level of healthiness, the amount of health care resources needed may be reduced.

Conclusions

Today, a considerable amount of money is being spent on repairing buildings damaged by moisture, treating people who have become ill in their home or work environment and paying unnecessarily high energy bills. For the most part, technology exists to reduce these costs dramatically; however, the construction sector is generally not motivated to utilise the available information.

Building physics has the potential for builders to generate and for customers to save large sums of money each year. Easy-to-use tools for the sector are needed to highlight the economic benefit of key decision-making during design. This would help to create a smoother transition to designing better buildings than the present state of affairs.

References

- Apte, M.G., Fisk, W.J. & Daisey, J.M. (2000) Associations between indoor CO₂ concentrations and sick building syndrome symptoms in U.S. office buildings: an analysis of the 1994-1996 BASE study data, *Indoor Air*, **10**, pp. 246-57.
- Arnetz, B.B. (1999) Model development and research vision for the future of multiple chemical sensitivity, *Scandinavian Journal of Work and Environmental Health*, **25**, 6, pp.569-73.
- Barrett, P. & Stanley, C. (1999) *Better Construction Briefing*, Oxford: Blackwell Science.
- Blomberg, T. (2000) *HEAT2 A PC-Program for heat transfer in two dimensions. Manual with brief theory and examples*, TVBH-7215, Lund: Lund Institute of Technology; Cambridge, MA: MIT Building Technology Group.
- Burch, D.M. & Chi, J. (1997) *MOIST*, Washington: Government Printing Office.
- ECCP (2001), European Climate Change Programme [Online], European Commission, Available from: <http://europa.eu.int/comm/environment/climat/eccp.htm> [27 June, 2001].
- EREC (2000) Computer software programs for commercial/large building energy analysis, Energy Efficiency and Renewable Energy Network. Available from: <http://www.eren.doe.gov/consumerinfo/v102.html> [27 June, 2001].
- Fisk, W.J. (2000) Review of health and productivity gains from better IEQ (Indoor Environmental Quality), *Proceedings of Healthy Buildings*, Helsinki, 4, pp. 23-34.
- Gertis, K. (2000) *WUFI*. Stuttgart, Germany: Fraunhofer Institut Bauphysik.
- Harderup, L.-E. (1999), *RISK 1: Manual och teori (Manual and Theory)*, TVBH-3036, Lund: Lund Institute of Technology (in Swedish).
- Hatush, Z. & Skitmore, M. (1998) Contractor selection using multicriteria utility theory: An additive model, *Building and Environment*, **33**, pp.105-15.
- J6hannesson, G. & Levin, P. (1998) Building physics -no way around it, in *CIB World Building Congress Proceedings CD-ROM*, Gävle, 7-12 June, pp. 2-7.
- Luthander, P. (2001) Skanskas bygglarvorsakade mögel (Skanska's construction carelessness caused mould), *Dagens Nyheter*; 13 February, AS (in Swedish).
- Milton, D.K., Glencross, P.M. & Walters, M.D. (2000) Risk of sick leave associated with outdoor air supply rate, humidification, and occupant complaints. *Indoor Air*: **10**, pp.212-21.
- Ministry of Housing (1990) *Code and construction guide for housing*, North York: Ontario New Home Warranty Program, Technical Research and Training Department.
- NES (2000) The NES software catalogue, National Energy Services Ltd. Available from: <http://www.nesltd.co.uk/software.htm> [27 June, 2001].
- Nevander, L.E. & Elmarsson, B. (1994) *Fukt handbok (Moisture handbook)*, 2nd edition, Stockholm: AB Svensk Byggtjänst (in Swedish).
- Samuelson, I. (1998) CIB W40 Heat and moisture transfer in buildings -trends and future perspectives, *CIB W40 Heat and moisture in buildings*, Kyoto, Japan, 7-10 October, pp. 5-9.
- Samuelsson, M. (2001) Moderna museet är mögelskadat (Modern Museum Damaged by Mould), *Svenska Dagbladet*, 14 June, p.2 (in Swedish).

- Sandin, K. (1990) *Värme; Luftströmning; Fukt (Heat; Airflow; Moisture)*, 2nd edition, Lund: Lund Institute of Technology (in Swedish).
- Sundell, J. (2000) Building related factors and health, *Healthy Buildings*, Helsinki, **1**, pp.23-33.
- Swartz, J. (ed.) (2001) *U.S. 20-year plan will lead to healthier, more energy-efficient commercial buildings*, Ottawa: Institute for Research in Construction.
- Terr, A.I. (2000) Multiple chemical sensitivities, in Bardana E.J.J. & Montanaro, A. (ed.), *Indoor Air Pollution and Health*, New York: Marcel Dekker, pp. 269-278.
- Thörn, Å. (1999) *The emergence and preservation of sick building syndrome - research challenges of a modern age disease*, Doctorial Thesis, Stockholm: Karolinska Institute.
- Tolstoy, N. (1994) *The condition of buildings. Investigation methodology and applications*, TRITA-BYMA, Stockholm: Royal Institute of Technology.
- Wargocki, P., Wyon, D.P., Sundell, J., Clausen, G. & Fanger, P.O. (2000) The effects of outdoor air supply rate in an office on perceived air quality, sick building syndrome (SBS) symptoms and productivity, *Indoor Air*, **10**, pp. 222-36.
- Willers, S., Andersson, S., Andersson, R., Granten, J., Sverdrup, C. & Roseil, L. (1996) Sick building syndrome symptoms among the staff in schools and kindergartens: are the levels of volatile organic compounds and carbon dioxide responsible, *Indoor Built Environment*, **5**, pp. 232-35.
- Wolkoff, P., Clausen, P.A., Jensen, B., Nielsen, G.D. & Wilkins, C.K. (1997) Are we measuring the relevant indoor air pollutants? *Indoor Air*, **7**; pp. 92-106.

7.2 Paper II

Burke, S., Johansson, D. & Öberg, M. (2002). Decreasing a Buildings Operational Energy Costs through the Application of Building Physics Principles During the Design Phase. In: Sustainable Building Conference Proceedings, 2002,Oslo, Norway

Decreasing a Buildings Operational Energy Costs through the Application of Building Physics Principles During the Design Phase

Stephen Burke¹
Dennis Johansson²
Mats Öberg³

¹ Department of Building Physics, Lund University, Box 118, 221 00 Lund, Sweden. Phone: +46 (0)46 222 7386. Fax: +46 (0)46 222 4535. E-Mail: stephen.burke@byggtek.lth.se

² Department of Building Physics, Lund University, Box 118, 221 00 Lund, Sweden. Phone: +46 (0)46 222 0677. Fax: +46 (0)46 222 4535. E-Mail: dennis.johansson@byggtek.lth.se

³ Department of Building Materials, Lund University, Box 118, 221 00 Lund, Sweden. Phone: +46 (0)8 625 6800. Fax: +46 (0)9 625 6898. E-Mail: mats.oberg@byggtek.lth.se

The three authors have done the same amount of work with this paper

1. INTRODUCTION

Energy use in the building sector represents approximately 40% of the total energy use within the EU (Sjöström, 2000). The predominant part of this is related to the operational phase of a building project. The implications regarding the environment in addition to the economy, have led to an increased interest for energy conservation in buildings during all phases of their lives.

Building physics plays a key role in the design of energy efficient buildings. It is not always considered during the design of a building, yet it influences the energy use and thermal climate of a building over its entire life. Disregarding these principles can result in superfluous operational costs and environmental impacts.

This paper reports on an examination of a multi-family dwelling, built in 1998, located in Svedala, southern Sweden regarding building physics, indoor climate and energy performance. The objectives are to point out potential improvements and the resulting economic issues for this specific building and report the actual energy data and software for energy balance calculations.

2. METHOD

A modern, multi-family dwelling, layout shown in Fig. 1, was selected for this study. There is no basement or attic, no internal staircase or common heated areas in this building. The simplicity of this design was thought to make the energy calculations more precise by decreasing the uncertainty and the number of parameters. It is one of nine identical buildings located in the same area of Svedala. The typical outdoor temperature varies between -1 and 16 °C on average during the year and the difference between day-time and night-time is about 6 °C.

The construction consists of a traditional slab block frame of concrete cast *in situ* on prefabricated floor slabs with a brick clad, wooden joist curtain wall façade. The roof is a light structure of gypsum boards and mineral wool carried by timber trusses. The window area is 80%

on one length, 20% on the other with no windows on the gables. The particular building analysed in this paper has its 80% window area facing the north. The heat and hot tap water are supplied by way of hot water radiators. One exhaust condensing natural gas boiler located centrally in the building heats the water. A mechanical exhaust ventilation system removes air from the kitchens and washrooms. The intake is a simple slot in the wall located above each window. Each building contains eight apartments comprising a total of 520 m².

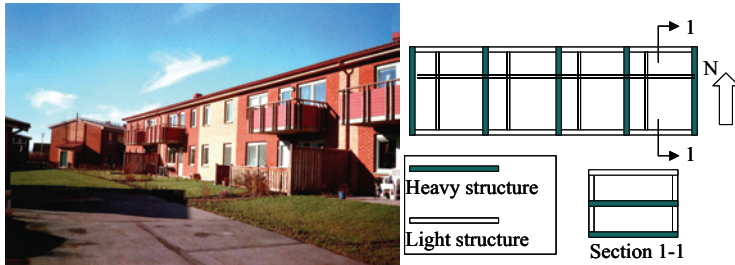

Figure 1 Multi-dwelling building Erlandsdal 1B in Svedala. Exterior (Facade), principal plan and section

Two apartments in the examined building were chosen for thermal imaging, air tightness testing and air flow rate metering. Apartment one is located on the second floor close to the outdoor roof and the gable of the building. Apartment two is located on the bottom floor in the centre of the building. The specific apartments were chosen due to the availability of the inhabitants during the time of the measurements.

The air tightness of the apartments was measured according to the Swedish standard SS 02 15 51 (SIS, Swedish Standards Institution) using a Minneapolis Blower Door, Model 3 outfitted with a C-Ring. The ventilation rates were measured according to the manufacturer's instructions for the Mätstos funnel and VelociCalc model 8355 air velocity meter apparatus. The thermal imaging was conducted using an Agema Thermovision 900, liquid nitrogen cooled thermal camera coupled to an Agema computer system. A Raytek Raynger MX4 advanced infrared thermometer was used to measure additional surface temperatures during the period the measurements were being taken. Glaser calculations were completed as outlined in Harderup (2000, 36-38) and the software package Heat2 (Blomberg, 2000) was used to analyse specific details of the drawings to determine the theoretical indoor wall surface temperatures, the effects of thermal bridging, and other possible design problems. The input boundaries for Heat2 were based on the outdoor and indoor temperatures measured on the day that the measurements were taken.

The actual use of energy for space heating and hot tap water as well as the electricity used for common areas over two one-year periods (2000 and 2001) were collected from the owner of the building, AB Svedalahem. Household electricity use for the year 2000 was obtained from the supplier, Sydkraft AB. The electricity readings were for the entire year, however the natural gas readings were available for each month. When the building was simulated, the different kinds of energy needed to be known.

Energy balance calculations were performed with two different software packages. They were 'VIP+' (Skanska IT-Solutions, 1996) and 'ENORM' (Svensk Byggtjänst). The advantages with VIP+ are one-hour time step simulations, modeling of air infiltration, solar gains and the influence of thermal capacity. The advantages with ENORM are its simplicity and that it is commonly used in Sweden. Input data regarding the technical characteristics were gathered from the construction documents and from field measurements. Data on internal gains from people and indoor temperature were estimated on the basis of the number of inhabitants. Internal gain from electricity was adjusted to the electricity bought by the households.

Parametric studies on the consequences concerning energy use and indoor climate were related to alternative designs concerning ventilation systems, the thermal capacity, air tightness, windows and the direction of the building. These simulations were performed with the energy balance programmes VIP+ and ENORM. Related impacts regarding life cycle economy were examined with Life Cycle Cost calculations where the present value method was used.

3. RESULTS AND DISCUSSION

3.1 Ventilation system

The results from a survey completed earlier indicated that the ventilation system was a weak point in these buildings. With regards to perceived indoor air quality and health related issues, the building and its services appear to be functioning well. However, cold air from the intakes above the windows generates dissatisfaction with the thermal comfort, especially during the winter. In several cases, the tenants have blocked the air intakes to counter this effect. This may result in creating a vacuum effect in the apartments, which in-turn explains why smells from the neighbours cooking are noticeable.

The ventilation rates were measured in the kitchen and washroom of both apartments. The initial flows set by Svedalahem for the kitchen and washroom were 10 L/s and 15 L/s respectively. These rates also conform to the minimum rates required for these rooms as set in the Swedish building regulations (Boverket, 1998). In apartment one, the measured flows were 6.3 L/s and 12.2 L/s for the kitchen and washroom respectively. In apartment two they were 9.3 L/s and 9.0 L/s respectively. These measurements follow Engdahl (1997), which shows that most ventilation systems in flats are quickly thrown out of calibration shortly after installation. In both instances, the flow rates are lower than the minimum required by law.

A parametric study was completed to show the influence in the Life cycle cost (LCC) if the system were a supply and exhaust system with a heat recovery unit. The initial cost would be three times the real cost, the maintenance cost would be higher but the energy use would be lower resulting in an equal LCC after 50 years. The LCC would be about 2040 SEK/m². The real rate of interest was 2% for energy and 3% for the rest. The heating cost was 0.46 SEK/kWh and the electricity cost was 0.65 SEK/kWh. Despite equal LCC, the indoor climate would be better.

3.2 Apartment air tightness

The air tightness in apartment one was measured to be 0.39 l/(s·m²) and apartment two was 0.22 l/(s·m²). Swedish building regulations require that the air leakage from a building must be under

0.8 l/(s·m²) therefore both flats are good in regards to air tightness. Apartment one seems to be normal however apartment two seems to have a very low number. This could be attributed to the fact that apartment one is located on the top floor and has a wood-framed ceiling, two wood-framed external walls and two concrete walls, only one of which is an exterior wall, and a concrete floor that has a heated flat under it. Apartment two, which is on the bottom floor, consists of only two wood-framed external walls, concrete walls towards neighbouring flats, a concrete ceiling and a concrete floor (insulated slab on ground).

If the tightness were increased, the energy balance with a exhaust system would not be affected as air leaks only substitute air through air intakes. With a supply and exhaust system with a heat recovery unit, a completely tight building would decrease the annual energy use with 3.5 kWh/m² compared to the average measured tightness and 6.2 kWh/m² compared to the regulated value.

3.3 Surface temperature aspects

With Heat2, the wood framed wall including the foundation and soil under the building was simulated in a steady-state environment using the actual temperature readings obtained in the field. This simulation showed the theoretical temperatures based entirely on the design of the walls, while the thermal camera showed the real temperature profiles. In this case the calculated values were accurate to within +3°C of the measured values. This difference can be attributed to workmanship since the computer software calculates based on a perfect fitting structure.

3.4 Actual energy use versus calculated

Electricity bought by the eight households totalled 13914 kWh, which corresponds to 26.7 kWh/m². The gain of energy from the 16 people living in the building was calculated by assuming 80 W per person of released energy and that half of their time is spent inside the apartment, which gives 1.23 W/m². Common electricity used for the block corresponds to 2.5 kWh/m² and does not contribute to the energy balance as the related heat is released outside of the climate shell. Ventilation rates used in the calculations were 25 l/(s·flat) based on the final inspection rate. Figure 2 shows the annual energy use for the building.

Actual energy use for space heating and tap water heating in the actual building for 2000 and 2001 was 145 kWh/m² and 151 kWh/m². This is a bit higher than the average energy use 140 kWh/m², for new multi-dwelling buildings according to 'Miljövårdsberedningen' (2000). The use of electricity, 26.7 + 2.5 = 29.3 kWh/m² is a bit lower than the average 35 kWh/m² (Ibid). The energy use for space heating and tap water heating for the neighbouring houses were lower eventually because of a lower demand for hot tap water. The year 2001 had 12% more degree hours than 2000, which explains the difference in radiator heating need between the measured building and the calculated building.

If the need for radiator heating in the summer is zero, all the energy for June, July and August must go to heating the tap water. With that assumption, the tap water energy demand for year 2000 should be 95 kWh/m² and for 2001, 77 kWh/m², which are high values. The Trelleborg project (Johansson and Johansson, 1999) indicated 36 kWh/m² and the ENORM default value gives 46 kWh/m². More research is needed to find the reasons behind the high summer energy use. Possible ways could be to compare cold-water use for the different houses or to make gas

readings every hour and check the night consumption to point out possible leaks and extraordinary behaviour.

The calculated energy use depends a lot on the need for hot tap water. In this case, the energy need for hot water was unknown. Therefore, the agreement between the actual readings and the calculations do not coincide. If the energy need for hot water was changed to the actual summer values, the calculations would agree better with the actual readings. The energy use for different kinds of energy is shown in Fig. 2 for the actual house as well as the calculated alternatives.

VIP+ is a more detailed software than ENORM thus also requiring some more input data. ENORM gives valid results for dwellings if the input data are plausible but any modelling of building physical aspects such as solar gains, thermal mass and air tightness is not possible.

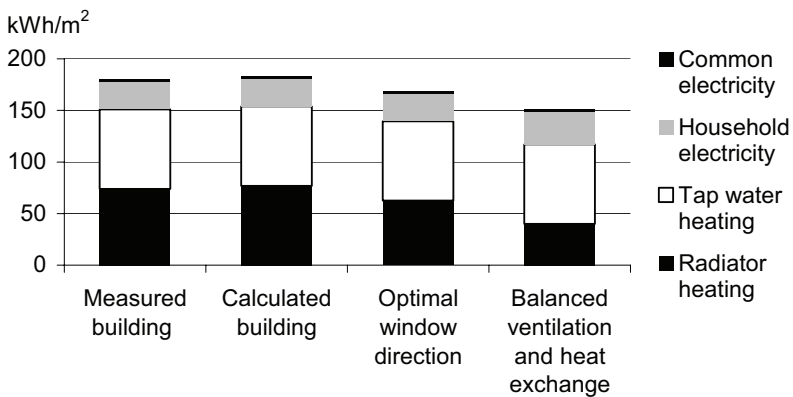

Figure 2 Total energy use 2001 for the examined building in Svedala. The tap water heating is estimated from the summer energy use for the actual measured building. The measured value of 2000 was used for household electricity as the value for 2001 could not be obtained.

3.5 Orientation of the building – solar gains – thermal capacity

The orientation of the windows of the original building is 80% to the North and 20% to the South. If the building is rotated 180° the required space heating is reduced by 13.4 kWh/m². The original building can be defined as a semi heavy structure with regard to active heat capacity. Parametric studies were conducted for also for a light and a heavy type of structure. With the original orientation of windows the annual difference between light and heavy structure is 2.8 kWh/m² and with the opposite orientation with more free excess energy from solar radiation the difference is 4.7 kWh/m² corresponding to 1.3 and 2.2 SEK/m², year.

Parametric studies on thermal mass, air tightness and orientation of windows indicate effects on annual energy cost of 1-6 SEK/m². These differences are rather small looking at the total annual costs but in the life cycle perspective they correspond to a present value of 30-170 SEK/m² and should thus be taken into account by the choice of design solutions.

4. CONCLUSIONS

The project in the case study in Svedala functions well except for the ventilation system that could have been a supply and extract system without increasing the life cycle cost. This would have benefited the energy use, the life cycle cost and the indoor thermal comfort. The problems with air quality and draught spotted in the questionnaire could have been solved by a supply and exhaust ventilation system. Maybe the indoor temperature could have been decreased with less heating need as a result. The air tightness of the building shell influences the energy use in buildings with balanced ventilation but not with mechanical exhaust ventilation. The building is tight compared to the regulations.

The building physics tools used in this study correlated well with each other and the simulation software indicated where there could be potential problems. A couple of measurements matched those of the calculated values, however most measured values fell a couple of degrees below the theoretical values. The tools also gave indications of areas that could be improved such as the ventilation air intake, and the effect of different ventilation systems on the life cycle cost however, the life cycle cost was not significantly reduced with a more complex system.

One problem with examining a house is the lack of models for user behaviour and a lack of measurements to split different energies and grounds for energy use. Measurements also need to be made with a smaller time interval.

5. REFERENCES

- Blomberg, T. 2000. *Heat2 A PC-Program for heat transfer in two dimensions*. Report TVBH-7215, Lund Univ. Dept. of Building Physics/Building Technology Group M.I.T., Sweden
- Boverket. 1998. *Boverkets Byggregler 1998*. Swedish Ministry of Housing and Planning, Karlskrona, Sweden (in Swedish)
- Engdahl, F. (1998). Evaluation of Swedish ventilation systems. *Building and Environment*, 33, (4), 197-200
- Harderup, L-E. 2000. *Metoder för riskanalys*. BFR. T13:2000. Stockholm, Sweden (in Swedish)
- Johansson, D. Johansson, R. 1999. *Energieffektivisering i Trelleborgs kommun*. Lund Univ. Dep. of Heat and Power Engineering. Lund, Sweden, Red. Pyrko, J., Chapter 10 (in Swedish)
- Miljövärdsberedningen. 2000. *Tänk nytt, Tänk hållbart*. Report from 'Bygga Bo Dialogue'. Ministry of the Environment, Stockholm, Sweden (In Swedish)
- Sjöström, C. 2000. Challenges of Sustainable Construction in the 21st Century. Keynote lecture. Proceedings RILEM/CIB/ISO Symposium on Integrated Life-Cycle Design, Helsinki, Finland
- Svensk Byggtjänst. *Enorm 1000, Manual*. Svensk Byggtjänst. Stockholm, Sweden (in Swedish)
- VIP+. 1996. *Computer program for energy balance calculations*. Skanska IT-Solutions. Solna, Sweden

7.3 Paper III

Burke, S. (2003). The renovation costs of crawlspaces due to moisture damage. In: Construction Economics and Organization - Proceedings of the 3rd Nordic Conference on Construction Economics and Organization, (111-7) April 23-24, Lund, Sweden

The Renovation Costs of Crawlspace due to Moisture Damage

Stephen Burke
Department of Building Physics, Lund University
221 00 Lund, Sweden
stephen.burke@byggtek.lth.se

Abstract

Moisture problems can take up to 10 years to reveal themselves in buildings. They are quite prevalent in Sweden today, potentially costing the economy a lot of money in repair costs. Moisture design is a method used by building physicists to determine the risk of a building developing moisture problems in the future if it is utilized during the design phase of the construction process. One design that is known to be problematic is buildings with crawl spaces. These buildings are one of the highest risk buildings of developing moisture problems, which can lead to indoor air quality problems. This report looks at the economic costs of repairing homes built with crawl spaces.

Introduction

Crawlspace have been around for a long time all over the world. In the past, houses were built above the ground on stonewalls. As man learned about insulation, they began to seal off this space in order to keep the heat in their buildings. They were also used to store food during the winter, as they were the ideal storage room, dark, moist and cold. It is these very same properties that cause problems for the structure of the buildings and this problem is one found throughout the world (Figley and Sieber 2002) (Matilainen and Pasanen 2002) (Hellström, L. 2002) (Arnstad, L. 2002) (Hinks and Cook 1999). Crawlspace are also one cause of mould problems in homes, which can be a serious health issue for the occupants causing allergies and sicknesses (Sundell 2000) (Haverinen et al. 2001b) (Haverinen et al. 2001a).

In Sweden, crawlspace were popular before the 1940's and again in the mid 1960's and 1980's (Tolstoy et al. 1984) (SCB 1972) (SCB 1980) (SCB 1988). From 1982 to 1991, 250000 houses, 25%, were built in Sweden with crawlspace (Elmroth et al. 2002). Crawlspace are a cheap method of building a foundation for a house, however if they are not constructed correctly, the reparation costs can easily exceed the money that is initially saved.

Crawlspace have the advantage of allowing people to access the area of a building that might otherwise be inaccessible. This can be useful for low cost repairs, easy access to, for example water leaks, floor insulation etc. Lately, crawlspace are becoming the cause of moisture problems that lead to health issues and costly renovation costs. Part of the problem can be attributed to the lack of knowledge in the area of building physics.

This paper looks at the potential economic repercussions of choosing a crawlspace as a foundation type, and is part of a larger project that looks at the economic effects of using building physics during the design phase.

Method

Småhusskadenämnden (SSN) is a Swedish organisation that was started in 1986 in order to assist people who have homes that are damaged by mould or moisture damage. SSN keeps every case documented in their archives and has done so since they began. The documentation includes the application for assistance, a technical review by a consultant, bids from construction companies to repair specific problems and the resulting decision, which includes the cost to renovate the building, the amount of deductible that the home owner is responsible for and the value of the house after the renovation is complete.

The economic data for this report was gathered from some of these archived documents. These documents cover applications submitted between 1986 and 1996. The documents used for this paper are currently located in the Department of Building Physics at Lund University.

Limitations

The houses looked at for the purpose of this paper had moisture-related damage that received money from SSN. This data does not take into account buildings that were not eligible for funding. There are limitations on the part of SSN for which houses are funded and for which are not. "SSN will only fund projects that are:

- Younger than 25 years old (if it is not renovated or expanded), before 1993 the limit was 30 years old
- Built before 1989
- Constructed for permanent use
- Serious damage at the time of application
- A one- or two-family house.

SSN will not fund projects if:

- The applicant does not own the house
- The damage is already repaired
- The damage is repaired through a court order or similar
- The building is classified as a summer cottage
- The damage is covered by insurance or warranty
- The damage was known to the owner at the time of purchase (under certain conditions funding can be approved)." (Svensson 1999, 3)

The author does not break down the costs for each case. Only the total reparation costs were used and the specific types of problems were not reported. All costs are in the monetary value of the year of payment. The costs have not been converted to today's value.

Crawlspaces

A crawlspace foundation comprises of a footer that supports concrete walls. The top of this space usually comprises of an insulated floor and the bottom is usually gravel or earth. These spaces are usually ventilated with outdoor air; however, some designs have no ventilation at all.

Some designs have a plastic layer lying on top of the gravel or earth. Usually today the layer is gravel so that the drainage is much better. This was changed because the earth bottoms were prone to collecting moisture.

Some of the newer solutions for a crawlspace is to turn it into another heated section of the house, complete with the same level of ventilation found throughout the house. This component is well insulated and is approximately the same temperature as the indoor environment (Elmroth et al. 2002).

Theory behind moisture design – building physics

Moisture design is a method of designing buildings taking into account moisture flows and levels (Airosto and Graad 1999) (Harderup 1998). This is based on the theories of moisture flow, air flow and heat flow in a building's envelope. A crawlspace with outside air ventilation has more risk of developing mould problems because of water condensing on the floor joists, concrete walls, insulation and floor surface. Mould begins growing when the moisture level is at a relative humidity of about 80%. During the summer it is not uncommon for the relative humidity to be at 100% in the crawlspace (Nevander and Elmarsson 1994, 293).

The temperature of the ground beneath a house changes temperature slowly during the seasons. In the winter there is very little chance of mould or moisture problems developing because the air entering the crawlspace contains very little water. The crawlspace is warmer than the outdoor air due to energy losses through the floor. In this case the relative humidity will decrease because of the outdoor air and the temperature in the crawlspace. In the summer the air entering is warmer and contains much more water than the air in the crawlspace can hold, the excess water is condensed out.

Understanding the complete system of temperature changes, energy loss from the building, saturation levels and mould have allowed researchers to simulate the crawlspace environment in order to determine the risk of mould growth (Harderup 2000) (Svensson 2001). This risk can also be indirectly used to predict the risk that a specific design will require renovations/repairs in the future.

Economic analysis of the cases

A total of 188 cases were examined from the archives of SSN. The information obtained included; the year of construction, the location, the crawlspace area (m^2), the total cost to repair the building (SEK), and the market value of the house after completion of the repairs. Of these, 142 cases had all the information available. The remaining cases were usually missing one of the following components; the year of construction, the crawlspace area or the market value, however all of the data was used because all the cases contained the cost of remediation.

Looking at Figures 1 and 2, it is not possible to see an obvious trend in the data. However, it seems like the data indicates that cheaper houses are generally more problematic and are more expensive per m² to repair than larger houses.

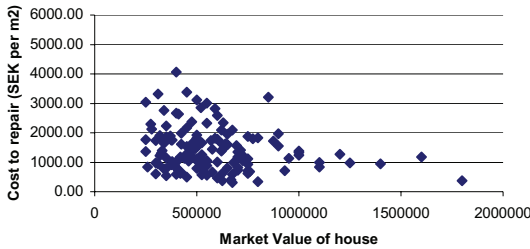

Figure 1: A graph of the market value of the houses compared to the cost to repair the damage (SEK) due to mould and/or moisture damage per m² of crawlspace area.

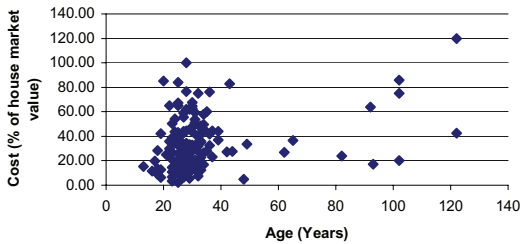

Figure 2: The relationship between the current age of the building and the cost to repair the damage expressed as the percentage of its market value.

In the cases studied, the average cost to repair a house with mould and/or moisture damage is 163000 SEK with a standard deviation of ± 81593 SEK. In relation to the value of the house, the average damage cost 33%, with a standard deviation of $\pm 21\%$, of the market value of the house to repair. Most of these repairs occurred when the houses were about 20 years of age.

The average year of the buildings examined was 1970. This agrees with the time frame for the data as seen in the limitations section. However, some buildings were over 100 years old. They were included because they had a section that met the requirements for funding.

In one case, the repair cost was equal to 120% of the market value (i.e. it cost more to repair the house than to build a new one of equal design). In this case the house was demolished, as economically it was not worth repairing the house.

Discussion

While it would be dangerous to draw any significant conclusions from the data in this paper, it is interesting to see the potential costs associated with a specific design. These are costs that are not advertised with the purchase of a building, however they are legitimate costs. It is interesting to look at it from the perspective of the building owner. If the owner borrows 1 million SEK to build a house, and the loan is paid back over 40 years, (assuming the loan is paid back in equal instalments on the principle loan) a repair cost after 20 years can result in the owner owing close to or more than the amount that they originally purchased the house for.

One defence against this situation happening to a homebuyer may be for the homebuyer to hire a competent engineering consultant that has a good history and knowledge of applying building physics. The homebuyer must trust their consultant and allow them to be involved as the client's representative during the design phase. In this way, the consultant can be instructed to look out for the homeowner's best interests and address small problems and issues that can be fixed quickly and cheaply during the design phase that could have a large impact in the future. Paying a little more for their services in the present can save a lot of money in the future (Yverås 2002).

Conclusions

If building physics principles are used one way or another during the design phase, the risk of damage of this magnitude occurring should decrease. The average cost to the homeowner to repair the damage has been about 33% of the house's market value. While it is not secure to draw any significant conclusions from the data used due to the spread of values, it is interesting to see the amount of money that is required after 20 years in order to maintain the indoor air quality of the building because of the problems cause by crawlspaces.

References:

- Airosto, A. and Graad, S. (1999) *Fuktdimensionering – Anpassning av metodik och tillämpning på Ekotopia i Aneby*. (Moisture design – Adaptation and application at Ekotopia in Aneby) Göteborg: Department of Building Physics, Chalmers University of Technology
- Arnstad, L. (2002) Sommar, sol- och villamögel. (Summer, sun- and house mould) In *Aftonbladet*
- Elmroth, A., Harderup, L.-E. , Hedström, J., Samuelson, I. and Svensson-Tengberg, C. (2002). Går det att bygga fuktsäkra krypgrunder? (Is it possible to build a moisture safe crawlspace?) In: *Bygg & teknik*: Maj, 2002
- Figley, D. and Sieber, R. (2002). Cleanup of microbial contamination in major building crawlspaces. In: *Indoor Air Monterey, USA*
- Harderup, E. (1998) *Fuktdimensionering med generell checklista*. (Moisture design by using general checklists) Lund: Department of Building Physics, Lund University, Report Nr: TVBH-3031

- Harderup, L.-E. (2000) *Metoder för riskanalys*. (Methods of risk analyses) Stockholm: Byggeforskningsrådet.
- Haverinen, U., Husman, T., Pekkanen, J., Vahteristo, M., Moschandreas, D. and Nevalainen, A. (2001a). Characteristics of moisture damage in houses and their association with self-reported symptoms of the occupants. *Indoor+Built Environment*, (10), 83-94
- Haverinen, U., Husman, T., Vahteristo, M., Koskinen, O., Moschandreas, D., Nevalainen, A. and Juha, P. (2001b). Comparison of two-level and three-level classifications of moisture-damaged dwellings in relation to health effects. *Indoor Air*, (11), 192-199
- Hellström, L. (2002) Hela förskolan är mögelskadad. (Entire pre-school damaged by mould) In *Borås Tidning*,
- Hinks, J. and Cook, G. (1999) *The technology of building defects*. London: E & FN Spon.
- Matilainen, M. and Pasanen, P. (2002). Transport of fungal spores from crawl space to indoors. In: *Indoor Air Monterey, USA*
- Nevander, L.E. and Elmarsson, B. (1994) *Fukt handbok*. (Moisture handbook) Stockholm: AB Svensk Byggtjänst.
- SCB, (1988), *Statistiska Meddelanden B022*, SM8801, Statistiska Centralbyrån, Stockholm
- SCB, (1980), *Statistiska Meddelanden Bo 1980:12.3*, Statistiska Centralbyrån, Stockholm
- SCB, (1972), *Statistiska Meddelanden Bo 1972:7*, Statistiska Centralbyrån, Stockholm
- Sundell, J. (2000). Building related factors and health. In: *Healthy Buildings*
- Svensson, C. (1999). *Utvärdering av Småbusskadenämndens arkiv avseende kryppgrunder - Genomgång av arkivet*. (Evaluation of the National Organisation for Aid to Owners of Private Small Houses archive with reference to crawlspaces) Lund: Avdelningen för byggnadsfysik, LTH, Report Nr: TVBH-3035
- Svensson, C. (2001). *Effekter av åtgärder i uteluftsventilerade kryppgrunder med fukt- och mögelskador*. (The effects of repairing outside air ventilated crawlspaces with moisture and mould damages) Lund: Avdelningen för byggnadsfysik, LTH, Report Nr: TVBH-3038
- Tolstoy, N., Sjöström, C. and Waller, T. (1984). *Bostäder och lokaler från energisynpunkt*. (Dwellings and buildings from an energy perspective) Gävle: Statens institut för byggnadsforskning,
- Yverås, V. (2002). *Performance indicators as a decision support tool*. Göteborg: Department of Building Physics, Chalmers University of Technology,

7.4 Paper IV

Burke, S. (2007). Crawl spaces in wood framed single family dwellings in Sweden: unwanted yet popular. *Structural Survey* 25(1), p. 51-60



Crawl spaces in wood framed single family dwellings in Sweden: unwanted yet popular

Crawl spaces in Sweden

Stephen Burke

Lund Institute of Technology, Lund, Sweden

51

Abstract

Purpose – This paper sets out to look at the different types of crawl spaces that are found in Sweden and why they are still being used in today's constructions despite the advice of building experts to avoid their use.

Design/methodology/approach – Literature reviews were performed to look at the types of crawl space foundations available as well as the advantages and disadvantages of each type and to look at the economic costs associated with repairing a damaged home that could be attributed to a crawl space foundation. Interviews were conducted with engineers with regard to moisture design issues in the Swedish building industry.

Findings – This study shows that there are five traditional types of crawl spaces used in Sweden: plinth, outdoor ventilated, indoor ventilated, unventilated, and suspended crawl space foundations, four of which are currently available to builders. Despite all of the available knowledge regarding the disadvantages and the past performance of the outdoor ventilated crawl spaces, companies in Sweden are still using this design and are still experiencing expensive problems.

Research limitations/implications – This paper is limited to Sweden. The situation in other countries was not specifically examined; however, it appears that other countries are also facing the same problems and this paper may provide some insight into why.

Originality/value – This study shows that there are many ways to construct a crawl space, some of which are considerably less risky than others. The study also indicates that the building industry in general seems to lack the theoretical background or incentive to utilize these variations properly or completely move away from these designs.

Keywords Building specifications, Condensation, Structural design, Control system characteristics, Job descriptions, Sweden

Paper type Research paper

Introduction

Background

Crawl spaces have existed for a long time all over the world. In the past, houses were built above the ground on stonewalls. In cold climate regions, this solution worked well from a mould and moisture perspective, however they required much more energy during the winter time. As man learned about insulation, they began to seal off this space in order to keep the heat in the buildings. Crawl spaces were also a good place to store food during the winter, as they were the ideal storage room, dark and cold. It is these properties, combined with the moisture level, that are the contributing factors that make it such a risky construction if it is not modified. The problems with some types of crawl spaces are recurring ones found throughout the world (Figley and Sieber, 2002; Matilainen and Pasanen, 2002; Hellström, 2002; Arnstad, 2002; Hinks and Cook, 1999).

In Sweden, crawl spaces were popular before the 1940s and again in the mid-1960s and 1980s (Tolstoy *et al.*, 1984; SCB, 1972, 1980, 1988). From 1982 to 1991, 250,000



Structural Survey
Vol. 25 No. 1, 2007
pp. 51-60

© Emerald Group Publishing Limited
0263-080X
DOI 10.1108/02630800710740976

SS
25,1

houses, 25 percent of the total number of houses built in Sweden, were built with crawl spaces (Elmroth *et al.*, 2002). This trend appears to have increased. A report from Anticimex (2004) states that between 1990 and 2003, 56 percent of Swedish single family homes were built with crawl space foundations, showing that the industry still prefers to construct crawl space foundations.

52

Some of the general advantages with crawl spaces are that they allow access to the underside of a building both during the construction and operation processes. This can be useful for a number of reasons, some of which are: keeping costs down for prefabricated buildings by reducing the amount of time needed to mount the building on its foundation, keeping repair and maintenance costs low, easy access to, for example water leaks, floor insulation etc. Increasingly in Sweden, poorly designed and constructed crawl spaces are becoming the cause of moisture problems that lead to health issues and costly renovations and repairs (Svensson, 2001). Part of the problem can be attributed to the lack of knowledge in the area of building physics/building science (Redlund, 2003).

Outdoor ventilated crawl spaces are known to be one of the causes of mould problems in homes, which can be a serious health issue for the occupants causing allergies and sickness (Sundell, 2000; Haverinen *et al.*, 2001a, b). The latest controversial problems occurring in Sweden regarding mould growth in a crawl space occurred in May of 2004 in approximately 200 houses between the ages of five- and seven-years-old (Orrenius, 2004). In this case, the construction company admitted that a design flaw was to blame and installed dehumidifiers to reduce the moisture level in the undamaged crawl spaces. The damaged crawl spaces were redesigned and rebuilt.

Aim

This paper looks at why outdoor ventilated crawl spaces are still popular with industry even though it is known that this specific design is problematic.

Method

The types of crawl spaces and their documented strengths and weaknesses were obtained via a literature search. The economic data for this report, as well as most information regarding outdoor ventilated crawl space foundations, was gathered from an archive of documents originally from the National Organisation for Aid to Owners of Private Small Houses, or Småhusskadenämnden in Swedish (SSN) which is currently located in the Department of Building Physics at Lund University. These documents cover applications submitted to SSN and include the application for assistance, a technical review by a consultant, bids from construction companies to repair specific problems and the resulting decision, which includes the cost to renovate the building, the amount of deductible that the home owner is responsible for and the value of the house after the renovation is complete. Using this archive it is possible to see what type of crawl space design is common as well as see the documented problems, solutions and total repair costs.

Interviews were conducted in 2003 (some results found in Burke and Yverås, 2004) that may shed some light on why this particular problem keeps reoccurring. Interviews were conducted with eight consulting engineers on the topic of moisture design during the building process. More information about these interviews can be found in Burke and Yverås (2004).

Limitations

This study does not cover concrete buildings, which are much more resistant to moisture damage for a number of reasons, (see for example, Kurnitski, 2000 for more

information) or multi-family dwellings. This study is also limited to Sweden and does not look at buildings or the building process in other countries. The performances of the other design types are based on a literature survey and they are not as well documented. Some of the crawl space designs in this paper are based on calculations and models and their performance in reality is not yet proven.

The outdoor ventilated crawl space houses looked at had moisture-related damage that received money from SSN between 1986 and 1996. They did not include houses in which J&W and SSC consulting companies were involved with. This data does not take into account buildings that were not eligible for funding. There are limitations on the part of SSN for which houses are funded and for which are not. The rules for this have changed recently and the following refers to SSN's policy for the time frame of the studied houses. "SSN will only fund projects that are:

- younger than 25 years old (if it is not renovated or expanded), before 1993 the limit was 30 years old;
- built before 1989;
- constructed for permanent use;
- serious damage at the time of application; and
- a one- or two-family house.

SSN will not fund projects if:

- the applicant does not own the house;
- the damage is already repaired;
- the damage is repaired through a court order or similar;
- the building is classified as a summer cottage;
- the damage is covered by insurance or warranty; and
- the damage was known to the owner at the time of purchase (under certain conditions funding can be approved) (Svensson, 1999, p. 3).

Only the total repair costs needed to attain a liveable standard were used and the specific types of problems were not reported. All costs are in the monetary value of the year of payment.

Brief crawl space theory

In Sweden, moisture design is a method of designing buildings taking into account moisture flows and moisture levels (Airosto and Graad, 1999; Harderup, 1998). This is based on the theories of heat, air and moisture flows through a building's envelope. These theories must be understood in order to assess and counter the risks with different foundations.

The heat flow determines how much heat is needed to keep the house at a comfortable temperature. Heat always flows from a higher temperature to a lower temperature via thermal radiation, conduction or convection of warm air. Using the most risky crawl space construction, the outdoor ventilated crawl space as an example, it is possible to see that heat flows down into the crawlspace and down through the ground. In modern constructions the floor joist is insulated to prevent heat loss. Therefore, the temperature in modern crawlspaces is significantly lower than that found only 20 years ago. This effect is valid year-round since, in the Nordic countries,

the summer is too short to heat the crawlspace to the same levels as in the past. Additionally, the surfaces of the materials in the crawl space can be cooler than the air. This is primarily due to thermal radiation. This occurs when heat radiates from a warmer surface to a colder surface, regardless of the air and surface temperatures. This can result in an increased risk of developing mould problems because the surface temperatures in the crawl space can become colder than the air temperature.

In the outdoor air ventilated construction, outdoor air is used to ventilate the construction. The idea is that this air will be used to remove any moisture in the crawlspace resulting from evaporation from the ground and infiltration from external sources, e.g. rainwater, leaks, etc. This works well during the winter because the crawlspace air is warmer than the outdoor air due to thermal losses from the house allowing the air in the crawlspace to hold more moisture than the outdoor air. Therefore, the risk for mould growth or moisture problems is quite low during the winter months. Unfortunately, it has the opposite effect during the spring and summer. During this period the warm air brings a lot of moisture into the crawl space. This, in combination with the effect of thermal radiation, infiltration from rain and leaks can cause water to condense on the floor joists, concrete walls, insulation and floor surface. This problem can be exacerbated by a high amount of moisture in the soil evaporating into the crawl space environment if there is no polyethylene layer.

The evaporation rate from the ground in a crawlspace varies with the type of material, the surface area of wet material exposed to air, the temperature of the air, the humidity of the air and the temperature of the soil. However, condensation does not even need to take place as mould begins growing on wood materials when the moisture level is at a relative humidity of about 80 percent. During the summer it is not uncommon for the relative humidity to be at 100 percent in the crawl space (Nevander and Elmarsson, 1994, p. 293).

This of course assumes that the crawl space does not have a negative pressure compared to the building. In this situation the pressure difference can pull moisture through the construction and into the crawl space resulting in the same effect found during the summer time. Understanding the complete system of temperature changes, energy loss from the building, saturation levels, impact of various ventilation systems and mould have allowed researchers to run simple simulations of the crawl space environment in order to determine the relative risk of mould growth (Harderup, 2000; Svensson, 2001). This risk can also be indirectly used to predict the risk that a specific design will require renovations/repairs in the future. Understanding these risks can help engineers design a better crawl space.

Types of crawl spaces

Crawl spaces can basically fall into one of five different types:

- (1) *Plinth foundation* – a building resting on top of pillars or piles with an open space under the building.
- (2) *Outdoor air ventilated crawl space* – many types within this group, all share the property that they are ventilated with outdoor air, either naturally or mechanically.
- (3) *Indoor air ventilated crawl space* – crawl space ventilated with indoor air.
- (4) *Unventilated crawl space* – an air sealed crawl space (very little ventilation).
- (5) *Suspended foundation* – an old type of foundation where the building sits on top of large stones. No longer an option for new buildings in Sweden (Åberg, 1995).

Plinth foundation. A building resting on top of pillars or piles with an open space under the building is called a plinth foundation. Usually, there are load bearing beams of wood or concrete panels between the pillars and the floor is insulated in the same manner as the exterior walls. The underside of the building differs with regard to the other exterior surfaces in that it is not exposed to direct precipitation. The environment under the building is comparable to the outdoor environment (Aberg, 1995):

- **Advantages.** The primary advantage with the plinth foundation is that it is possible to place a building over virtually any type of terrain. A building can be placed over uneven stone or bedrock without having to blast, over water, etc. This construction type is also easy to build and design. If the underneath of the building is left open to the outdoor environment there is very little risk of mould or moisture damage occurring (Aberg, 1995).
- **Disadvantages.** The disadvantages with this type of foundation are that the ground floor can be quite high above the ground which places more demands on complying to handicapped laws. If one of the sides is walled up, there is an increased risk of mould growth and/or moisture damage from condensing water vapour. The height also plays a role in regards to risk level. Generally, the higher the building is above the ground, the lower the risk for moisture problems (Aberg, 1995).

Outdoor air ventilated crawl space. There are many different variations of this type of design, but most modern designs share some key characteristics. One is that there is earth or stones on the ground (for drainage and capillary breaking purposes) covered by a polyethylene layer. The second is that there are vents in the exterior wall to allow ventilation of the area. Sometimes this ventilation is supported by a mechanical extraction ventilation system. The third is that the floor joist above is insulated. Some of the modifications of this design include insulation on the ground above the poly, insulation covering the underside of the floor joists, insulated external concrete walls, a system of ventilated floor joists, and/or a dehumidifier installation to remove excess moisture from the air:

- **Advantages.** The outdoor ventilated crawl space has the advantage of access. With these crawl spaces it is easy to access the underneath of the building for maintenance, repairs, and inspections. This type of crawl space is also very well documented.
- **Disadvantages.** This type of crawl space has been shown to be very risky and unstable during the warm and moist months of the year. Burke (2003) stated that the cost of repairing a crawl space foundation in Sweden ranged from €8,888 to €26,890, based on SSN's archives containing 142 cases. Anticimex (2004) also released a report stating that repair costs ranged from €3,292 to €27,400, depending on the severity of the repairs. The simplest and cheapest variant of this design has no insulation in the ceiling of the crawl space and the ground is covered by a polyethylene layer. The more expensive and less risky variation has insulation on all six boundaries (i.e. walls, ground and ceiling). Other variations may have a mechanical ventilation system or a dehumidifier to control moisture levels. Using dehumidifiers is a relatively new technique and its effectiveness is not well documented.

Indoor air ventilated crawl space. With an indoor air ventilated crawl space, the crawl space is designed as another warm area of the house and is treated as another room.

There are no vents to the exterior environment, there is no insulation in the floor joists, the entire crawl space is insulated with non organic insulation on the ground and, either the centre, the exterior, or the inside of the crawl space's concrete wall is insulated. The area also has its own ventilation by either having a supply and extract system, or by extracting all of the house's indoor air via the crawl space (Åberg, 1995):

- *Advantages.* The advantage of using an indoor air ventilated crawl space is that there is very little chance for problems occurring, assuming that the proper steps have been taken to ensure that ground water will not be a problem. This type of solution also prevents radon or other gases from entering the living area. This type of crawl space is also very adjustable in regards to ventilation and pressure differences. Another advantage is the thermal comfort of this system. By its design, it can keep the floor temperature higher than in other systems, unless a heating system that is built into the floor is used. In buildings with concrete floor joists the concrete beam is able to dry faster due to double sided drying (Åberg, 1995).
- *Disadvantages.* The primary disadvantages with this system have to do with the ventilation system and vapour barrier. The home owner must always ensure that the ventilation system functions properly or the system will fail. In addition, the construction must be properly sealed with the same level of air resistance as the exterior walls to keep out moisture from the ground (Åberg, 1995).

Unventilated crawl space. An unventilated crawl space is similar to the indoor air ventilated crawl space, without the ventilation. Additionally, inorganic materials, i.e. concrete must be used to insure that this design functions properly since it is likely that the relative humidity will reach higher levels than 75 percent:

- *Advantages.* The unventilated crawl space is a simple design that, if constructed properly, needs very little maintenance. Since this type of crawl space is rare, there is not much documented experience regarding this foundation. However, an analysis of this type of construction has been done by Åberg (1994). The results from this report show that this type of foundation can function well, but it must be designed with a high moisture load in mind. A cost analysis from this study showed that the unventilated crawl space costs about 33 percent less to build than an outdoor ventilated crawl space containing insulation on the ground and under the floor joists.
- *Disadvantages.* Åberg's report (1994) stated that the use of any organic materials in this design type will lead to mould and moisture problems. The study also showed that the humidity level in this crawl space is determined primarily by the amount of moisture evaporated from the ground. Of the two modifications, one being a heated space with no polyethylene layer on the ground, and the second being a non-heated space with a polyethylene layer acting as a moisture barrier, the heated space variation performs better. However, the humidity level is high enough to cause mould growth on wood and therefore can be seen as a higher risk construction in comparison to other options. One method to help decrease the humidity level is to install a dehumidifier in the crawl space to remove any excess moisture (Åberg, 1995).

Suspended foundation. A suspended foundation is an old type of foundation where the crawl space walls are just a pile of stones. This type of foundation is no longer used with new build houses. This type of foundation may not be significant outside of

Scandinavia, however within Scandinavia it is a unique crawl space type that must be addressed when renovating old buildings (Åberg, 1995):

- *Advantages.* This type of crawl space functioned in the past because of the heat losses from the building through the floor. It was a cheap construction because the foundation was comprised of large stones.
- *Disadvantages.* If constructed using traditional materials and designs, i.e. no insulation under the wooden floor, this can be considered a low to medium risk construction. This type of construction does not meet current Swedish building code in regards to thermal properties and is therefore no longer used. However, with respect to an old construction, if an old building's envelope is upgraded using current building materials, such as insulation, and the amount of heat lost through the crawl space via the floor is reduced, this type of construction becomes an outdoor ventilated crawl space which is susceptible to the same failure rates and risks. It is for this reason that it is undesirable to renovate an old building with a suspended foundation without re-designing and re-building the foundation.

Discussion

There are many advantages and risks associated with all of these constructions and these properties determine where each type can and cannot be used, assuming the crawl space is built properly. Unfortunately, they are very difficult to design and construct properly. During the 7th Nordic Building Physics Symposium in Reykjavik, Iceland (Hagentoft, 2005), a workshop was held with the title "Building Physics and the motors for change. How do we change common practice?" During this workshop it was agreed by all the building physics experts present that they are not certain how to build a crawl space that will function perfectly, that is, a risk-free crawl space.

There is a new type of crawl space that has been developed around the end of the 1990s called the TEEG crawl space. This design is a modified indoor air ventilated crawl space with enough height in the centre for a person to stand. This design is able to bypass newer Swedish occupational health and safety codes that do not allow workers in spaces under 60 cm high. This code could have been used as a tool to prevent new houses with crawl spaces from being constructed, however this variation allows crawl spaces to be legally constructed.

Whenever the media writes about crawl spaces failing, they usually do not say which type of crawl space has failed. Most of the time, they are referring to the outdoor ventilated crawl space foundation with wooden floor joists. This causes the public to associate all crawl spaces with high risk constructions, mould growth, moisture damage and high repair costs. As shown in this report, this is only true for one specific type of crawl space out of four possible options available for new buildings.

A different message can be found with professionals in the building industry. Some argue that crawl spaces are good, low risk constructions, however they often do not specify which type. This can be true for the indoor air ventilated, the TEEG and the plinth foundations, but if they say this in the context of an outdoor ventilated crawl space then it is likely that they are not up to date with current research in this area.

The amazing thing today is that companies in Sweden are still using the outdoor ventilated crawl space in new constructions, and in some cases, these new buildings have mould growth within five years. A study undertaken by Arfvidsson and Sikander (2002) can give some insight into why these problems reoccur. This study found that clients assume that their new building will be constructed in a manner that gives the lowest risk of moisture damage. The engineers, architects and builders on the other hand feel that

SS
25,1

clients are not willing to pay this extra cost and therefore choose a cheaper, higher risk solution. The ironic thing is that the survey also found that 95 percent of the clients are willing to pay extra to reduce the risk of moisture damage occurring in their building!

58

A similar study by Burke and Yverås (2004) explored this a little further and found that almost all engineering consultants never tell the clients that they are not getting a building that has the best moisture performance available. Another contributing factor to this problem is since the clients do not specifically allocate resources to improve the design from a moisture perspective, most engineers must rely on only their education, since they are not allocated time for reading new material, reflection, or follow-ups on old projects and designs. One finding from this study (Burke and Yverås, 2004) was that because of the lack of this feedback loop, the amount of experience an engineer had (years working in the industry) had no effect on their ability with regards to building physics/building science issues. Education was the only measure of their ability with these issues. It is important to stress that these findings are only in the context of moisture flows and not other areas of engineering.

In relation to this, the client constructing the building and deciding the details is not always the end user of the building. This can be seen in some areas of Sweden where a number of lots are developed at the same time by one company. In this situation single family homes are built and sold to the end user. The end user here has no control over technical details involved with the house. In this case, the engineer's client is the builder. They are only obligated to see that the building does not develop problems during the first two years of the building's existence, after which the home owner is financially responsible. The problem here is that mould and moisture problems can take five to ten years before becoming apparent.

When asked why outdoor ventilated crawl spaces were being used in their constructions, one company stated that their decision was based on economic calculations. That the cheapest way for them to mount a pre-fabricated single family home was by mounting it on a crawl space foundation. This is a weak argument and hints that perhaps the crawl space was not designed correctly. Åberg (1994) carried out a cost analysis of three variations of crawl spaces and the indoor air ventilated crawl space was 33 percent cheaper than the "best" outdoor ventilated crawl space design (insulation on all six boundaries with mechanical extraction ventilation). Therefore, it is economically unwise to have an outdoor ventilated crawl space as a foundation for a building with regards to initial cost, operating costs and repair costs. Additionally, it has been shown earlier that living in a home with mould and/or moisture damage can have a negative influence on people's health.

If the construction company needs to use a crawl space foundation for their building, the client should be made aware of the various alternatives, risks and extra costs associated with them. Most clients would not select an outdoor ventilated crawl space if they knew they would have to spend a significant amount of money within 5-25 years in order to repair their home.

Conclusions

There are five different types of crawl spaces, four of which are currently available to builders and one being an old design. Due to all the negative publicity associated with outdoor ventilated crawl spaces and the fact that they are publicly referred to only as crawl spaces, the two other types of crawl spaces that function well are also looked upon negatively. If designed and constructed correctly, the indoor air ventilated crawl space can be a cheaper alternative with many advantages over an outdoor air

ventilated crawl space. The same functionality is retained and the home owner has the benefit of a warmer floor.

There is a lack of documented knowledge with regards to some of the modifications made to the outdoor ventilated crawl space in addition to the plinth and indoor air ventilated crawl spaces. More research is needed to determine how well each type and modification of crawl space performs in practice, for example, if installing a dehumidifier is a cost effective solution for protecting a crawl space from moisture problems.

Despite all of the available knowledge regarding outdoor ventilated crawl spaces, companies in Sweden are still using this design and are still experiencing expensive problems.

References

- Åberg, O. (1994), *Oventilerad varmgrund (Unventilated crawl spaces)*, Department of Building Construction, Lund University, Lund (in Swedish).
- Åberg, O. (1995), *Krypgrundsgrunder (Crawl space foundations)*, Byggnadsnämnden (Building Research Council), Stockholm (in Swedish).
- Airosto, A. and Graad, S. (1999), *Anpassning av metodik och tillämpning på Ekotopia i Aneby (Moisture design – adaptation and application at Ekotopia in Aneby)*, Department of Building Physics, Chalmers University of Technology, Gothenburg.
- Anticimex (2004), *Fukt- och mögelskadad krypgrund – Ett faktum för 175000 svenska villaägare (Moisture and mould damaged crawl spaces – a fact for 175000 Swedish single family home owners)*, available at: www.anticimex.se/fileobjects/3834_040907-Anticimex%20Rapport%20om%20Krypgrunder.pdf (accessed November 22, 2006).
- Arfvidsson, J. and Sikander, E. (2002), *Fuktsäkert byggande – Enkätstudie om kunskapsläget (Moisture safety in the building process – a survey study regarding the current state of knowledge)*, Gothenburg, Fou-Väst report 0205 (in Swedish).
- Arnstad, L. (2002), "Sommar, sol- och villamögel, (Summer, Sun and house mould)", newspaper article, Aftonbladet.
- Burke, S. (2003), in Hansson, B. and Landin, A. (Eds), "The renovation costs of crawl spaces due to moisture damage" *Construction Economics and Organization – Proceedings of the 3rd Nordic Conference on Construction Economics and Organization, Lund Sweden, April 23-24*, pp. 111-17.
- Burke, S. and Yverås, Y. (2004), "A Swedish perspective on the prevention of moisture problems during the building's design phase", *Nordic Journal of Surveying and Real Estate Research*, Vol. 1 No. 1, pp. 102-13.
- Elmroth, A., Harderup, L.-E., Hedström, J., Samuelson, I. and Svensson-Tengberg, C. (2002), *Går det att bygga fuktsäkra krypgrunder? (Is it possible to build a moisture safe crawlspaces?)*, Bygg & teknik (Buildings and Technology), Stockholm (in Swedish), May, pp. 20-6.
- Figley, D. and Sieber, R. (2002), "Clean-up of microbial contamination in major building crawlspaces", *Proceedings of the Indoor Air Conference, Monterey, CA*.
- Hagentoft, C-E. (2005), "Workshop: building physics and the motors for change. How do we change common practice?", paper presented at the 7th Nordic Building Physics Symposium, Iceland, June.
- Harderup, E. (1998), *Fuktdimensionering med generell checklista (Moisture design by using general check-lists)*, Report Nr: TVBH-3031, Department of Building Physics, Lund University, Lund (in Swedish).

- Harderup, L.-E. (2000), *Metoder för riskanalys (Methods of risk analyses)*, Byggforskningsrådet (Building Research Council), Stockholm (in Swedish).
- Haverinen, U., Husman, T., Pekkanen, J., Vahteristo, M., Moschandreas, D. and Nevalainen, A. (2001a), "Characteristics of moisture damage in houses and their association with self-reported symptoms of the occupants", *Indoor + Built Environment*, No. 10, pp. 83-94.
- Haverinen, U., Husman, T., Vahteristo, M., Koskinen, O., Moschandreas, D., Nevalainen, A. and Juha, P. (2001b), "Comparison of two-level and three-level classifications of moisture-damaged dwellings in relation to health effects", *Indoor Air*, No. 11, pp. 192-9.
- Hellström, L. (2002), "Hela förskolan är mögelskadad. (Entire pre-school damaged by mould)", *Borås Tidning (Borås News)*, newspaper article (in Swedish).
- Hinks, J. and Cook, G. (1999), *The Technology of Building Defects*, E&FN Spon, London.
- Kurnitski, J. (2000), "Crawl space air change, heat and moisture behaviour", *Energy and Buildings*, Vol. 32, pp. 19-39.
- Matilainen, M. and Pasanen, P. (2002), "Transport of fungal spores from crawl space to indoors", *Proceedings of the Indoor Air Conference, Monterey, CA*.
- Nevander, L.E. and Elmarsson, B. (1994), *Fukt handbok (Moisture Handbook)*, AB Svensk Byggtjänst, Stockholm (in Swedish).
- Orrenius, N. (2004), *Mögel i nya Lundavillor (Mould in Lund's new houses)*, newspaper article from *Sydsvenskan* (in Swedish), available at: <http://sydsvenskan.se/lund/article68356.ece> (accessed November 21, 2006).
- Redlund, M. (2003), *Hög luftfuktighet ger byggsador (High humidity leads to building damage)*, Byggindustrin (The Building Industry), No. 34 (in Swedish).
- SCB (1972), *Statistiska Meddelanden Bo 1972:7 (Statistics Bulletin Bo 1972:7)*, Statistiska Centralbyrån (Statistics Sweden), Stockholm (in Swedish).
- SCB (1980), *Statistiska Meddelanden Bo 1980:12.3 (Statistics Bulletin Bo 1980:12.3)*, Statistiska Centralbyrån (Statistics Sweden), Stockholm (in Swedish).
- SCB (1988), *Statistiska Meddelanden Bo22, SM8801 (Statistics Bulletin Bo22, SM8801)*, Statistiska Centralbyrån (Statistics Sweden), Stockholm (in Swedish).
- Sundell, J. (2000), "Building related factors and health", *Healthy Buildings Proceedings, Finland, August*.
- Svensson, C. (1999), *Utvärdering av Småhusskadenämndens arkiv avseende krypgrunder – Genomgång av arkivet (Evaluation of the National Organisation for Aid to Owners of Private Small Houses archive with reference to crawlspaces)*, Report Nr: TVBH-3035m, Department of Building Physics, Lund University, Lund (in Swedish).
- Svensson, C. (2001), *Effekter av åtgärder i uteluftsventilerade krypgrunder med fukt- och mögelsador (The effects of repairing outside air ventilated crawlspaces with moisture and mould damages)*, Report Nr: TVBH-3038, Department of Building Physics, Lund University, Lund (in Swedish).
- Tolstoy, N., Sjöström, C. and Waller, T. (1984), *Bostäder och lokaler från energisynpunkt (Dwellings and buildings from an energy perspective)*, Statens institut för byggnadsforskning (The State Institute for Building Research), Gävle (in Swedish).

Corresponding author

Stephen Burke can be contacted at: stephen.burke@byggtek.lth.se

To purchase reprints of this article please e-mail: reprints@emeraldinsight.com
Or visit our web site for further details: www.emeraldinsight.com/reprints

7.5 Paper V

Wihlborg, C. & Burke, S. (2006) Decreasing the risk of moisture damage to prefabricated building components - from production to construction. *Research in Building Physics and Building Engineering*. Montreal, Canada, Taylor & Francis Group.

Decreasing the risk of moisture damage to prefabricated building components – from production to construction

C. Wihlborg & S. Burke

Building Physics, Lund University, Sweden

ABSTRACT: Some Swedish prefabricated home manufacturers have noticed that some prefabricated building components have been returned because of mould and moisture damage despite the fact that these components have undergone quality control during construction. The building components are constructed in a factory setting and wrapped with polyethylene for protection from the elements. In some cases, the components are stored outdoors until delivered. It was found that by wrapping the components indoors, the indoor environment of these components is similar to the indoor environment of the factory, depending on the materials used and the amount of moisture in the materials. Since these units are not ventilated, condensation occurs in the component when stored outdoors. If stored for too long, moisture damage can occur. This paper looks at how the risk of mould and moisture problems can be reduced as well as the effects of transportation on the indoor environment of the components.

1 INTRODUCTION

1.1 *Background*

Handling moisture issues in the building process is not always apparent from both the design and production phases, as has been discussed in Wihlborg (2005). From the production's perspective, it mostly involves weather protection for sensitive components until the building envelope is finished. It also includes the drying of building materials to an acceptable level before the surface materials are added.

The building industry has, in their own way, begun to industrialise the building process, which means that their definition has not always been the same as in other industries. One of the primary goals with this is to reduce the construction costs. However, there is also an underlying goal to improve the moisture control of the building as a positive side effect. By building a total weather protection around the building or shortening the mounting time by constructing the components indoors, it is possible to reduce the exposure time to the weather and prevent precipitation from damaging the building.

Unfortunately, a new problem has arisen in regards to the prefabricated building components. Some of the components are developing moisture and mould problems despite their protection from precipitation and quality controls.

1.2 *Aim*

New processes can change the dynamics of moisture control, which means that old routines are also deemed

inappropriate. New routines must be developed to avoid new problems and therefore the problems must be well thought out in advance. This paper looks at how the industrialised process in Sweden can be modified in order to keep moisture under control thereby reducing the risks of moisture and mould problems.

1.3 *Method*

In order to determine the current industrialisations effect on moisture problems, it is essential to identify the different steps in the production process. This paper is based on previous interviews completed by Yverås & Wihlborg (2004) in addition to literature studies. Two of the companies interviewed are Hjaltevadshus and Open House. They are two companies that both have begun to implement industrialised construction processes. Both companies are different in regards to the extent of industrialisation; however they both share the common factor that they both produce prefabricated elements.

2 SIMPLIFIED PROCESS

2.1 *Production*

Prefabricated modules or components are manufactured indoors using modern tools. Some of these can include robotics, but the majority of the work is done by people. This is much the same as in the auto industry, where there are originally unskilled workers trained to do specific functions. There is usually a production line where the modules are transported

from one work station to the next. However the modules are not all the same. Since customers demand different properties for their building, each module is considered to be a custom build. This can be a little different from the auto industry where the same cars are reproduced with different options. As the final step in the production process, the modules are wrapped with poly to protect them from the elements during storage and transportation.

2.2 Storage

During the production phase of this process, materials containing moisture are used to build the module. It is very important that these materials contain low amounts of moisture when assembled so that they do not damage other materials in the module (Nevander & Elmarsson, 1994). For this reason, the manufacturers set maximum moisture levels for specific materials at the time of delivery and are careful regarding the storage of these materials. The materials are typically stored in a controlled environment usually around 20°C and 50% relative humidity.

Once the modules are finished, they are either transported to the job site for mounting or they may be stored for anywhere from days to months before being transported. Since they are protected from the elements, they are usually stored outdoors.

2.3 Transport

The modules are transported by tractor-trailer or lorry from the manufacturing plant to the job site. During transport, the modules can be exposed to precipitation and water from the road that might get past the plastic wrap. They may also be stored on the job site before being mounted. One additional issue revolving around the transportation phase is the type of equipment used and what methods are used to load and unload the modules.

During a long transportation time, it is a fact that condensation within the module can occur due to the cooling of the material in the module. The total risk of damage occurring due to moisture increases when the material is transported long distances and/or is stored outdoors for extended periods of time. This will be investigated in more detail in Section 4.

2.4 Mounting the module

Most of the prefab producers deliver finished components to a ready job site, i.e. the foundation is finished and ready for the modules. In this regards the building's services must also be prepared in advance and it must match the prefabricated modules.

Despite the fact that prefabricated modules are protected from the elements during transportation, this protection must be removed before the product is

mounted. There is usually a time delay between when the product is mounted and when it is fully protected from the elements as a part of the entire building, i.e. the façade is in place, the roof is tight and the windows are installed. During this time delay it is possible for the product to be exposed to precipitation and wind that can leak into the main building via joints between the modules that are not yet sealed.

It is very important that the components be handled with care during all phases. Movement of the module during transportation can lead to cracks; components such as windows, wall paper, vapour barrier, tiles and the façade are all at a particularly high risk for cracking if the movements are too large.

2.5 Moisture

Many materials contain moisture in them. If the material is not in equilibrium with the surrounding air, this moisture evaporates until it is in equilibrium. (Nevander & Elmarsson, 1994). If this moisture is not removed through ventilation, heating or by other means, the risk of moisture damages occurring to the structure because of damp increases significantly. The amount of moisture depends on what materials are used. For example, a normal concrete slab can release 80–90 kg of water per cubic meter. (Burstrom, 2001).

3 RESULTS OF STUDY VISITS AND INTERVIEWS

As mentioned before, two companies were looked at for this report. One, located in Southern Sweden called Open House and the other called Hjärtevadshus. Open House has roughly 100 employees whilst Hjärtevadshus has 200 employees.

3.1 Production

Both companies produce modules which are joined together to form a completed construction. Both produces modules that are between 15 and 43 m² and are roughly 10–15 tons, or physically half of a single family home. Both produce their components indoors in a factory setting.

The Relative Humidity (RH) was measured in the factory at Open House and ranged from 30 to 45%, which is normal indoor environment for the months of November to January. The temperature ranged from 16 to 18.5°C. The heating system was lowered during the night to save energy, however the temperature did not increase a significant amount before the beginning of the work day. The RH is not controlled in the factory, like it is for example, in the window manufacturing industry. In the window industry, a typical factory environment is controlled year round to be 20°C and 50% RH.

The wooden materials at the time of delivery at Hjaltevadshus are about 13–14% moisture ratio by weight. When leaving the factory they should be at around 12%, however this figure is never checked. In the past, the Swedish National Testing and Research Institute checked 5% of the houses so that the company could achieve the P-Mark stamp, which is a quality label in Sweden. However, according to the manager Peter Stenfelt, this status symbol has lost its marking power and they have instead switched to the ISO certification which does not require moisture sampling.

In the window industry, wood coming in is checked, and the maximum moisture ratio by weight allowed is 15%. The material is then stored in a climate controlled building and the moisture ratio decreases to around 12%. Finished windows are shipped at around this level. Wood is monitored so that the moisture ratio is not too low or too high.

3.2 Storage

The storage of modules can potentially occur at two different phases. The first time storage can occur is after the module is produced in the factory. It was stated that typically the modules are produced on a just-in-time basis for both companies, however sometimes it is necessary to store the modules for a period of time due to delays in the project or over production from the factory's side. In both cases, the modules are wrapped in a plastic wrap to protect the module during transportation from precipitation and wind. In the case of Hjaltevadshus, some school modules were stored for a period of one to two years. To help lower the risk of moisture problems, vents were installed in the plastic wrap to allow limited ventilation of the modules. They have not observed any moisture damages.

The second time a module may be stored is after delivery. If the job site is not quite ready for the module it is possible that it will be stored on site until it is mounted.

Due to observed condensation in their modules during transportation and storage, Open House no longer plaster or paint any gypsum surfaces until after mounting. This was done to prevent mould growth on the painted surfaces.

3.3 Transport

Transportation differs between the two companies because of the dimensions of their modules. Open House can transport two modules per truck. Typically, they send three trucks at a time with a warning vehicle. Hjaltevadshus produce much larger modules and they can fit one per truck. Here how the module is lifted is essential as to not damage the interior finish of the building. Despite this, some damages do occur and they are repaired once the house is completely mounted.

3.4 Mounting the module

Since the two products are different, the methods used to mount the modules are also different. Open House has a more risky mounting phase because the modules are exposed to the outdoor environment until the roof modules and external wall modules are all in place and sealed. Hjaltevadshus also must expose their modules to the outdoor environment but the risk is lower because the modules are larger and already have the roof. In this respect, the risk is only present until the modules are completely connected.

To help prevent problems caused by precipitation, Open House has a direct connection to the Swedish Meteorological Institute and can determine if they will have rain 10 minutes before it occurs. This gives them time to cover open modules and optimise the mounting process. Hjaltevadshus does not make use of such a service; however they know that it takes 5–6 hours to make their modules rain tight. If the weather forecast gives rain for that day they do not mount any houses. If the forecast gives showers or light drizzle they proceed claiming that their method is not interrupted by showers, or small quantities of rain.

4 DISCUSSION AND ANALYSES

4.1 Construction methods

In Sweden the crawl space foundation is a common solution to mount prefabricated houses on. This type of foundation is considered to be a cheap and simple solution especially in rocky and rough terrain. It also makes it easy for the entrepreneurs to mount the modules as well as connect all of the installations such as pipes and cables that run between the modules.

Research reports and findings show that this type of foundation is very prone to suffer from mould growth and rot. In Björk et al. (2001) the authors strongly discourage the use of outdoor air ventilated crawl space foundations. Nilsson & Tornevall (1995) have investigated P-marked houses, of which some were Hjaltevad's houses, between 3 to 4 years after completion. The report reveals that all of the investigated houses suffered from mould growth of some sort in the crawl space. Furthermore, Anticimex¹ recently released a report based on investigations conducted by the company between the years 2001 to 2003. From the cases with crawl space foundations, some 35% had such extensive mould problems that Anticimex recommended the house owners take appropriate actions. Based on the report Anticimex states that about 175000 Swedish single family houses suffer from damaged crawl spaces.

¹ A private company that started out working with pest control but now specialises in creating internal environments that are healthy and safe.

We can see from a number of different sources including the world's experts in building physics, that that the outdoor air ventilated crawl space foundations are not recommended in new constructions (Iceland, 2005). However, Hjaltevadshus claims that they have not had any problems at all with the crawl space foundation except a few cases in which the entrepreneur who is responsible for the foundation, had made a flawed foundation.

The fact that Hjaltevadshus claims to have no problems could be the consequence of a passive knowledge feedback from their customers and that Hjaltevadshus only takes responsibility for any upcoming problems during a warranty period of two years. Mould growth in a crawl space is normally a process that takes several years, hence is not visible during the warranty period.

To repair a damaged crawlspace is usually in the range of 30000–250000 SEK (equal to about US \$4000–33000) which the home owners, in most cases, must cover themselves (Burke, 2003; Anticimex, 2004).

4.2 The Importance of information

The industrialisation of the building process shows a trend that personnel employed in the building sector lack proper education. Therefore it is highly important that the employers supply some kind of education on how to avoid moisture problems. The same type of education or information should also be mandatory for the entrepreneurs that mount the modules on the construction site so that they are aware of how fragile the modules are when exposed to high levels of moisture and water.

4.3 Condensation

All fabrication of house modules could suffer from high levels of moisture. The problem is especially dramatic when in combination with cold climates and in contact with cold surfaces. If the relative humidity of the air exceeds the vapour saturation point, which is temperature dependant, the excess moisture will condense. Therefore it is very important that the climate within the modules be controlled, especially during longer periods of storage, transport and mounting.

To examine these risks we will use measurements taken from the Open House plant in south Sweden, from one of their modules during transport and from one of their construction sites. The temperature as well as relative humidity has been logged in these three locations during the period 2003-11-04 to 2004-01-26. This is a quite average climate considering the location and time of year. Unfortunately the logger that was located inside one module was not to be found after the transportation and mounting of the module, hence some assumptions needed to be made in order to assess the risk.

Table 1. Relative humidity calculations of for the days with the lowest outdoor temperature during the measured period.

Module's storage temperature [°C]	Vapour saturation for module's storage temperature [g/m ³]	Assumed moisture content in the sealed modules [g/m ³]
1	5.19	7.8
-0.5	4.67	7.8
-4	3.52	7.8

Based on the remaining measurements we look at a worst case scenario and assess the risk of condensation in a module. A few assumptions need to be made.

Firstly, the climates in the modules are the same as in the factory at the time when the module is sent to storage or to the production site. That is a fair assumption since all the built in material is stored within the factory before being mounted in the modules. Also a few materials that are used contain moisture in some forms that needs to be dried out, like the water in mortar, wallpaper glue, paint etc.

Secondly, there is no air exchange between the inside and the outside of the module. This assumption is less likely due to the use of poly and the problems with wrapping the modules perfectly tight. Some, even if it is very small, air exchange is to be expected. The air in the module is expected to have a higher relative humidity than outside; hence the module would only gain from such an air exchange.

During the studied period the highest moisture concentration in the factory was measured to be 7.8 g/m³. During the following three weeks the three coldest readings at the construction site were: 11-25-2004 (1°C), 11-29-2004 (-0.5°C) and 12-07-2004 (-4°C). For every read temperature a corresponding vapour saturation point is found in Nevander & Elmarsson (1994, p. 476).

Table 1 shows that the assumed moisture content in the sealed module is greater than the actual saturation points for three of the coldest days during monitoring. This high moisture level results in condensation in the modules. It would therefore be interesting to do the calculation backwards to find a safe storage temperature at which the relative humidity will no longer be considered a risk to the materials in the module. A new assumption can be made: that the critical relative humidity is 85% (Nevander & Elmarsson, 1994).

$$\frac{7.8}{0.85} = 9.2 \text{ g/m}^3 \Leftrightarrow 9.7^\circ\text{C} \quad (1)$$

For the given assumptions we can see that either a heat source or a dehumidifier is needed in the modules until they are mounted and the ordinary heating system has been activated. This is necessary to minimise the risk of moisture damages in the modules. The need

for either is obvious during the time of year when the outdoor temperature falls below 9.7°C as shown in Equation 1.

4.4 Connections

To increase the effectiveness of prefabricated house modules, the pipe and cable installation needs to be carried out in the factory as much as possible. This also means more connection points need to be connected than in a traditional, in-situ, erected house since there has to be a lot of connections between the modules. According to Andersson & Kling (2000) some 2.8% of the whole built environment in Sweden suffers from water damages. The damages are mainly due to two reasons: Firstly, leaking pipes and pipe connections and secondly, leaking vapour barriers in bathrooms. Hence, it would be obvious to strive for less connections and corrosive pipes in buildings.

4.5 Moisture control during the building process

According to an interview survey (Arfvidsson & Sikander, 2002) it is obvious that the building sector is a bit confused about the demands on moisture control within a building project. They discovered that no actor in the building process takes proper responsibility for moisture control questions. The same survey showed that 95% of the building sectors clients were willing to pay extra for a moisture safe building. This could be perceived as a win-win concept where the prefabrication companies gives a great opportunity to follow up and control the levels of moisture in the delivered product and the clients at the same time are guaranteed a dry and healthy product.

5 CONCLUSIONS

5.1 General

The interviews and study visits reflect a picture where, in the push to industrialize the building process, the dynamics and repercussions of moisture control has been overlooked. Perhaps the fact that the buildings are produced indoors gives the false sense of security that moisture problems cannot occur. This train of thought must be removed and replaced by a broader understanding of the entire production process.

The interviewed companies have come different distances in regards to the industrialization process. One can see that the level of awareness regarding moisture has increased somewhat, but it is not proportional to the level of industrialization. Moisture issues are handled in much the same manner as before which includes a fuzzy boundary when responsibility is questioned and inadequate quality control throughout the entire building process.

5.2 Tips and advice

- One should avoid the outdoor air ventilated crawl space foundation. Instead, a slab on ground or similar foundation is recommended.
- Active feedback is necessary to follow up new innovative production methods. One tip is to follow up production both during erection and then again after some 3 to 5 years after the building has been taken into use.
- The module manufacturer should be responsible for the modules until they are delivered, thus including transportation.
- The climate in the modules should be controlled at all times.
- Information on how to build with moisture control is important and should be spread to all involved personnel.

REFERENCES

- Andersson, J. & Kling, R. (2001) Bygg vattenskadesäket (Build to prevent water damage). In *VASKA visar vägen (VASKA shows the way, Swedish)* The Building Research Council, Stockholm.
- Anticimex (2004) *Fukt- och mögelskadad kryppgrund. (Moisture and mould damaged crawl spaces, Swedish)* at: <http://www.anticimex.se>
- Arfvidsson, J. & Sikander, E. (2002) *Fuktsäkert byggande. Enkätstudie om kunskapsläget. (Damp proofing construction – a survey study about the current application of knowledge, Swedish)* Göteborg: FoU-Väst, 0205
- Björk, F. et al. (2001) *Skador i småhus – Gamla beprövade misstag? (Damages in single family homes – old proven mistakes? Swedish)* Stockholm: Royal Technical University, Work Report 2001:6.
- Burke, S., (2003) The Renovation Costs of Crawl Spaces due to Moisture Damage. In: Hansson, B. & Landin, A. (eds), *Construction Economics and Organization – Proceedings of the 3rd Nordic Conference on Construction Economics and Organization*, April 23–24, Lund Sweden.
- Burström, P.G. (2001) *Byggnadsmaterial. Uppbyggnad, tillverkning och egenskaper (Building material, production and properties. Swedish)*. Studentlitteratur, Lund.
- Höganäs, C.C., (2004) *Våtrumskläddnad. (Wet room lining, Swedish)* <http://www.choganas.se>
- Iceland, 2005, *7th symposium on Building Physics in the Nordic Countries* discussion with experts in building physics regarding crawl spaces.
- Nevander, L.E. & Elmarsson, B. (1994) *Fukthandboken, (Moisture handbook)* 2nd Edition, Svensk Byggtjänst, Stockholm.
- Nilsson, I. & Tornevall, M. (1995) *Egenskaper hos P-märkta småhus efter 3–4 år. (The properties of P-marked houses after 3–4 years, Swedish)* Borås SP AR 1995:19.
- Stenfelt, P. (2004-11-04) Hjältevadshus. Interview.
- Wihlborg, C. (2005) *Vår för uppstår fuktskador? Erfarenheter från tre skadefall.* Göteborg: FoU-Väst, 0503.
- Wihlborg, C. & Yverås, V. (2004) *Fuktens inverkan vid industrialiserat byggande.* Lund: Work report.
- Åberg, U. (2004-10-18) Open House. Presentation/Interview.

7.6 Paper VI

Burke, S. And Yverås, Y. (2004) A Swedish Perspective on the Prevention of Moisture Problems during the Building's Design Phase, *Nordic Journal of Surveying and Real Estate Research* 1(1), p. 102-113

A Swedish Perspective on the Prevention of Moisture Problems During the Building's Design Phase

Stephen Burke¹ and Veronica Yverås²

¹ Department of Building Physics, Lund Institute of Technology,
Box 118, 221 00, Lund, Sweden
stephen.burke@byggtek.lth.se

² Department of Building Physics, Chalmers University of Technology, Sweden
veronica.yveras@jm.se

Abstract. *Moisture problems in buildings are increasingly being reported in the mass media in Sweden, often leading to some controversial stories about companies and their building processes. Using building physics and building performance principles during the design stage can often prevent most problems from occurring. One of the big questions is, with all the available knowledge about designing a building, how can these problems still be occurring in new buildings? This paper explores this question by interviewing some engineering consultants on how they evaluate the performance of a building, and to what extent knowledge about building physics theory is being used during the design process to prevent moisture problems from occurring. It was found that building physics is not used extensively in the building industry due to many reasons. The lack of good design tools and the fact that clients do not request it are two main reasons. However, it was revealed that clients do not request it because they either have no interest in spending the extra money for a better design, or they do not know it is optional and just assume everything is taken account of in the final design. Furthermore, the consultants do not advise them on the available options applicable for their particular design. Due to the method used to analyse the interviews, an unexpected relationship between education level and their perceived level of awareness of building performance issues emerged. It appears that the higher the level of education of the consultant, the more they are aware of the impact of performance issues in a building's design. Their experience level does not appear significant in this relationship, however this cannot be proven and will require more studies to verify.*

Keywords: *building physics, building performance, interviews, tools, consultants, education, and economics*

1 Introduction

Moisture design appears to be a growing trend in Sweden. This can be explained by the attention from mass media that various projects around Sweden have been

getting. Specifically, projects involving mould in buildings and moisture damage in newly constructed buildings, largely multi-family dwellings (Jelvefors 2002; Luthander 2001). This trend is increasing because the media has brought it to the attention of the public that the consultants do not perform a moisture analysis on a building's design during the design phase. The consultants admit that clients do not request moisture design because the clients assume that it is included in the normal design process (Arfvidsson and Sikander 2002, p. 14).

Building physics in Sweden is defined as the study of the transport of heat, moisture, and air through a building's envelope in relation to both the indoor and outdoor climate (Hagentoft 2001). It is a key area in the development of energy efficient, healthy, moisture safe and durable buildings. It is this field of science that focuses on the prevention of moisture problems during the design phase of a building. Please note that the Swedish definition of building physics does not include lighting and acoustics, unlike most other countries around the world.

In many countries, architects are responsible for the design and detailing of a building. In the Swedish building industry it is common that the architects are only responsible for the form and shape of a building and engineering consultants are responsible for the technical specifications. Recently, Sweden has seen an increase in the amount of mass-media attention that problematic buildings are getting; even to the point of being damaging for the companies involved in all phases of the construction (Luthander 2001; Jelvefors 2002; Samuelson and Wånggren 2002). One of the big questions is, with all the available knowledge about designing a building, how can these problems still be occurring in new buildings?

The aim of this paper is to explore this question by interviewing some engineering consultants on how they evaluate the performance of a building, and to what extent knowledge about building physics theory is being used during the design process to prevent moisture problems from occurring.

The driving forces behind this study are two research projects that are both looking at the use of building physics based design tools for engineering consultants in the building industry. By tools we mean any aid that influences the design. Tools can be either computer or paper based in the form of checklists, graphs, tables, simulations etc.

One project, *Performance indicators as a tool for decisions in the building process*, (Yverås 2003) deals with the problem of developing a design tool that will increase the application of building physics in the early stages of design. Performance indicators can assist in this decision-making and help to avoid failures that would otherwise reduce service life. Even though knowledge about designing a building is widely available, incorrect decisions are all-too common. Consequences from poor decisions can include a reduction in service life arising from conditions such as mould growth, rot and corrosion. These conditions can be avoided, but not without the application of robust knowledge based on the principles of building physics. However, this requires more than knowledge; it demands tools that designers can understand and use. It is important, therefore, to

have a clear picture of what is required of any decision support tool, which is why the interview study is important in the further development of the performance indicator tool.

The second project, *Tools for determining the economical effects of building physics aspects during the building process*, (Burke 2003) investigates, studies and quantifies the economical benefits in using the knowledge from building physics as a design and decision tool in the building process. Problems in the building process related to building physics will be identified in co-operation with the building industry. Existing calculation programs, databases, statistical inquiries will be compiled into useful, easy to use tool packages especially designed to give adequate information about the costs and risks associated with different designs. These interviews were necessary to gain insight into what extent building physics is utilised in the building industry, and what types of applications designers want that would enable them to apply building physics theories more easily to designs.

2 Method

As mentioned in the background, the two projects behind this paper are developing design tools to be used during the design phase. Information and insight was needed about the design process in Sweden as well as the types of tools that designers would want to use. Since these tools are intended for designers during the design phase of a project, we focused our information gathering on designers who will potentially have use for our tools.

Of the various methods considered – for example experimental, literature review and surveys – the latter seemed to offer most promise. Due to the nature of our enquiry, we felt that an exploratory survey was more likely to reveal the key features of the underlying problem than either of the other methods.

Questionnaires were considered as the primary method for gathering information. However they have the disadvantage of being too linear. In addition, the information generated could not be anticipated, so it was not considered appropriate to gather the information by questionnaires. Interviews were more appropriate by allowing us to be dynamic, with the ability to probe interesting information to a much deeper level than is possible by questionnaires.

The questions for the interviews were formulated around two themes. One was to get a picture of the consultants' conditions used to evaluate the performance of a building (i.e. their perception of the building process), and the second was to determine their level of comfort and experience in working with building physics issues.

To ensure that all interviews yielded comparable results, they were based on five principal questions with about 26 more specific questions. They consisted of open and closed questions that allowed us to assess various aspects of the interviewees unbeknownst to them. For example, a respondent can be assessed on his or her familiarity with the latest information and technology without directly

asking. The closed questions allowed us to categorise the interviewees into predetermined categories. The five principal questions were:

1. How would you describe the design process of a building?
2. What are the most important performance requirements when designing a building?
3. How do you evaluate the performance of a building?
4. What influences do economical aspects, such as market conditions and market trends have on the design of a building?
5. Do you and your co-workers feel comfortable working with building physics issues, i.e. heat, air and moisture issues?

Interviews were conducted with eight building consultants over the span of two weeks and all consultants answered all of the questions. Two consultants declined to be interviewed because they were too busy but were positive to the interviews and recommended alternative people, whom accepted. All but one, the building physics professional, were chosen at random with no information about them prior to the interviews. It was decided to stop conducting interviews at eight because after the 5th or 6th interview very little new information was obtained.

The results were analysed based on the grounded theory approach, which "is a method for discovering theories, concepts, hypotheses, and propositions directly from data rather than from a priori assumptions, other research, or existing theoretical frameworks" (Taylor and Bogdan 1998, p. 137). In other words, there were no assumptions made as to what results we would obtain prior to the interviews.

3 Results and discussion

3.1 Relationships

Table 1 shows the profiles of the interviewees. Category refers to their general level of ability regarding the application of building physics to a design. Category A covers expert engineering consultants, category B covers the average ability expected from a building engineering consultant, and category C covers engineering consultants with very little ability. Some of the consultants indicated that experience is very important when dealing with the performance of a building. However, this was not apparent when analysing the interviews. Arfvidsson and Sikander (2002, p. 16) also found that consultants want more feedback on past projects, which supports our finding that they do not get adequate feedback on past projects, hence decreasing the value of experience. When looking at the experience level compared to the perceived level of awareness, i.e. the whole picture of the design process combined with a comprehension of complex performance issues and an awareness of the current levels of technology base, there did not appear to be any pattern. However, the level of education appeared to be related to their level of awareness. Figure 1 shows how we perceived the level of awareness for each person interviewed.

Table 1. Profiles of those interviewed

Category	Education hh	Experience
A	PhD in building physics	20 years
	Civil engineer + extra education building physics	15 years
B	Civil engineer	30 years
	Civil engineer	15 years
	Civil engineer	15 years
	Civil engineer	7 years
C	2-year engineering diploma	6 years
	High school	40 years

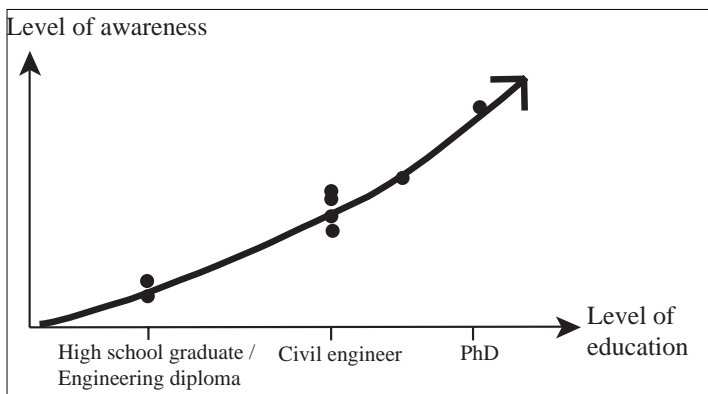
**Figure 1.** Perceived correlation between level of education and awareness

It is important to remember that the engineers in category C, and part of category B, did not have access to an expert. This could affect the results in this study since a lot of education flows internally from the experts in the companies. Other companies with experts and category C employees working together may have a totally different level of awareness due to the expert's influence. More in-depth studies would be needed to investigate this relationship further.

There also seemed to be different attitudes towards the required time directed to handle moisture control issues during design. Those within category A said

that they would like to have more time whereas those in category C did not even allocate time especially for these issues. This was stated despite that they stated earlier that these issues are highly prioritised. They did however motivate it by using safe and well-known designs, referring to their own experience. However, their experience on well-known designs can be questioned as the consultants rarely have the time or the opportunity to return to, or follow-up projects that were finished 10 years ago or more. In practice, the long-term design for engineers is 2 years, according to one of the interviewed engineers.

When asked who is responsible for most of the performance problems experienced in buildings today, the consultants in categories A and part of B were also including themselves when asked. This was the opposite of the others (categories C and part of B), who blamed anyone else but themselves. These results partly agree with Arfvidsson and Sikander (2002, p. 13) who concluded that no actor in the building industry is willing to take responsibility for moisture prevention issues when designing a building.

Some of the questions dealt with how comfortable the consultant feels if they must work alone on problems dealing with building physics. In most cases the answer to this question was related to whether or not they have access to an expert in building physics. If the consultant had access to an expert, they were usually not comfortable working with these issues and usually sought advice from their expert before finalising a design. The consultants in this category acknowledged that since the media attention began, they have felt even less comfortable with these issues and rely heavily on their experts. Those without an expert in-house were more prone to saying that they felt very comfortable with building physics issues.

The group within the profession that has lower education level relies mainly on their experience. But if professionals rely mainly on experience, how do they know when there are gaps in their knowledge or whether some of their standard rules are no longer applicable (Barrett and Stanley 1999). Decisions made without knowledge of their consequences can have dire effect (Ellis and Mathews 2001).

One might easily draw the conclusion that people with less knowledge would suffer from insecurity more so than those with expert background. This was not the case during the interviews. Members of group C, showed a great deal of confidence and no worries about the complexity of building physics. Confidence is defined as the strength of a person's belief that a specific statement is the best or most accurate response (Peterson and Pitz 1988). In other words, it is a measure of how strongly they believe what they say. So far, no study has been performed that examines if there is any correlation between mistakes in design and the level of knowledge of the designer. However, there is a great deal of research, which indicates that people are often more confident than they are correct (Blanton *et al.* 2001). Blanton *et al.* (2001) states that educators may meet obstacles from people's overconfidence about their knowledge when trying to educate them. As the individual with the PhD said, "People *think* they can moisture proof a building, but they can't and I have to correct the problems later, which takes a lot of time."

3.2 Consultant/engineer and liability

Noting that moisture analysis requests began increasing after the media reported moisture problems, we began to wonder what the role of a consultant is in the Swedish construction industry and what their liabilities are. One tool used is called ABK 96 (Byggandets kontraktsskommité 1996). It is a standard contract template that explains in detail how engineering and architectural consultants should conduct themselves. It also describes the limitations of liability that a consultant has. Most consultant companies use this voluntary contract to guide the consultants and also the client – consultant relationship. Each party is informed of what is expected of them by the other.

Despite this, there also appears to be some confusion around the labels of consultant and engineer for consulting companies, even though it is not spoken of. A consultant is defined as “an expert who gives advice.” (Princeton 1997a) An engineer is defined as “a person who uses scientific knowledge to solve practical problems.” (Princeton 1997b) Paragraph four (Byggandets kontraktsskommité, 1996, p. 5) states that the consultant must be competent, professional and have adequate knowledge to consult in the areas of their field. However, overconfidence and lack of awareness in building physics on the part of some consultants, can cloud the issue of a consultant having adequate knowledge for building physics issues.

From the interviews, it was obvious that many consultants expect to be told what to do by the clients without informing the clients of what is available. In this way some of the consultants take on the role of engineer. This change in attitude is reflective of the traditional methods of building design consulting when a lot of information was unknown and the designs were simpler. An example was one consultant who disclosed technical solutions to example problems during the interviews that are proven to lead to mould and moisture problems in houses.

If a client is an experienced buyer or an expert client, they will have predetermined tasks and technical solutions available for the consultant since they are usually aware of all the major problems and their solutions. However, not all clients are fully informed, almost all have some weakness, for instance the science of building physics is not known by a typical client. A statement during one of the interviews, “Clients don’t know enough (about building physics-issues) to have any requirements” supports this idea.

There are occasions where poor decisions have been made that have lead to a failure in performance. This was exemplified during the interviews where one described how she strongly advised the client not to follow the architects’ direction of having the outside wall continue into the ground without a base. Two years later the predicted problems arose and the plaster closest to the ground fell off due to frost erosion. Clearly this was a case where the client was not used to handling these issues, lacked the experience to make a correct decision and the consultant failed to present the information. The reasons are considered to be due largely to the inability of design engineers to encode and present the consequences

of a decision. By improving the quality of information during the design process, the client is better equipped to understand the different issues implicated in the project (Barrett and Stanley 1999). The consultant above admitted that by having real life cases to show, including a cost of the consequence, the outcome of this case might have been different.

The consultant in this case was not liable for the damages that incurred later because the consultant, firstly, recognised the problem and secondly, recorded their disagreement with the client in the protocol during the design phase. The consultant would have been liable for the damages if they did not inform the client of the problem, either voluntarily or unknowingly, i.e. was not aware of the consequences of a particular design feature. This case was not typical in that the consultant did a moisture analysis to determine the consequences.

The client usually assumes that the consultants they hired will solve all the known problems. The reality is that most engineering consultants, not all, are actually operating like engineering firms, in that they do not analyse a building from a building physics point of view unless asked specifically. Their reasoning being that changing the design requires more time, hence more money that clients are unwilling to pay. The result of this is that the minimum amount of work is done when analysing a building's design and the clients get very upset when problems occur.

One fact that they are neglecting to consider is that the cost of the building might actually decrease if the design is optimised using building physics. This could be in the way of material substitution, removing unnecessary components, or utilising a quicker construction method. In the U.K., quantity surveyors are able to calculate the cost difference of various designs. This position does not exist in Sweden so it is very difficult for engineering consultants to motivate changing the design based on building physics theory because of the difficulty in calculating the savings or extra costs associated with the changes.

3.3 Design tools

When asked what design tools were used when conducting the evaluation of a building from a building physics perspective, most replied that they did use some very basic ones. Two people, including the expert, built their own design tools from Delphi Pascal or Excel spreadsheets. Only the expert had a 'wish list' for what was desired in future tools. The others said they did not know since either their local expert uses the tools, or they did not use any.

When those who replied that they did not use any design tools were asked why, they replied that they were too costly to buy, too difficult to learn, required too much time to run the simulations, and not enough time was allocated to evaluate a building's design properly. These results follow Hien *et al.* (2000, p. 727) who found that "Most firms view the use of simulation tools as involving extra costs and effort but with little recognition and appreciation from the clients."

The most desired features of any computer-based tool, according to the

consultants, were that they had to be easy to use in terms of low level of input and output data. These are statements that contradict with what is typically produced by researchers. Researchers have too often failed to deliver numerical models and tools that are user friendly and that take into account the education and expertise of the likely user (Goodings and Ketcham 2001). Hien *et al.* (2000) reveals that designers regard current tools as user unfriendly with very steep learning curves; moreover, the output generated could be extremely difficult to interpret and utilise for design decision-making. Ellis and Mathews (2001, p. 1011) also confirm this and have identified that tools of today are:

- complicated (not user friendly)
- time consuming (too much input)
- require a high level of theoretical knowledge (to make the input and to interpret the results)
- Information needed is not available during preliminary design.

Regarding the wish list of the tools the answers can be categorised after what level of education the respondents have. Those within category C had no wish list. Category B directed their interest to simplify computer programs in order to make use of such programs, whereas category A people had a bigger picture and directed the use of wish tools that could be used to persuade the clients for better performance. Examples of these are tools that can show the consequences of a chosen design in terms of reduced service life due to mould, rot or corrosion and cost analysis programs. Energy calculation, heat flow and airflow programs were not mentioned by any of the interviewees despite the fact that these topics all fall under the area of building physics.

Building industry related journals were also mentioned as being a tool that provides them with useful information. However, the interviewee did not state what specific types of journals they referred to.

In another civil engineering area, geotechnics, a trend is the growing number of experts (post doctoral) joining conventional firms instead of making a career within the university (Goodings and Ketcham 2001). This trend helps bring existing research into practice where it is most needed. Augenbroe (2002, p. 891) agrees with the idea of making more use of experts in the industry stating, "The latter trend recognizes that the irreplaceable knowledge of domain experts and their advanced tool sets is very hard to match by 'in-house' use of 'dumbed down' designer friendly variants". This difference between having a design tool, versus having an expert in the company is significant, and this was reflected in the results of the interviews. All consultants who had access to an expert made use of them constantly, and all stated that they would be uncomfortable working with moisture control problems if they did not have access to their expert. They much prefer having the expert than using a simplified tool.

3.4 The bigger picture

Despite advances and knowledge in the construction industry in the past decades, it appears that this knowledge is not generally implemented until it becomes a requirement. This was explained by Becker (1999, p. 526) who states, "incorporation of new concepts into an existing professional activity field can be accomplished only if the right infra-structure, composed of some basic conditions, is present:

- the acting parties recognize the significance of these concepts and their contribution to improving the results of their work,
- clear routines and friendly working tools for smooth incorporation of the new concepts are available, and
- young new professionals are educated to regard the new concepts as an integral part of the profession."

These statements can be seen in the Swedish construction industry today. From the interviews, we saw that some recognise the significance of the concepts of building physics and building performance. Most indicated that there were no good design tools available for designing a performance building. Some did not even know that there were tools available on the market today.

With the third point, compliance and company tradition will quickly change the young professionals into operating like the other members of a company. Even if they want to make changes according to what was learned in school, a higher power can quickly overrule any decisions that they feel are unnecessary. The younger workers learn quickly not to make these decisions again in the future.

4 Conclusions

The interviews conducted with the engineering consultants in the Swedish construction industry suggest that experience might not necessarily be important when it comes to consultants and the topic of building physics performance. In addition, the higher educated consultants felt less comfortable and showed less confidence when working with these issues than their less educated counterparts. Their comfort and confidence levels were also inversely related to their amount of access to an expert in building physics, i.e. the more access they had, the less confident they were in working with these issues. The consultants with no expert support felt very confident and comfortable in working with these issues, however the quality of their work could be questionable due to a lack of feedback loops in the system. Awareness, education, and a view of the bigger picture are all needed to effectively deal with performance problems in the current construction industry. However, even if they possess all of these traits, there are many obstacles out of their control that can prevent an effective analysis of a building's design. Some of these obstacles include having to make do with the amount of time allocated to the analysis phase of a building, meeting the client's demands, the architect's demands, the level of competence of the consultant, whether or not they have

access to an expert in building physics, and the types of tools they have at their disposal.

The interviews indicate that problems are still occurring in new buildings today because either clients do not request the correct design options, the designers do not include these options in their designs due to the extra time it takes, or the constructors disregard some basic issues which lead to problems during the construction phase. Sometimes clients do not request extra design work because they believe it increases the total cost and they will not be personally affected by the improvements, for example clients who build public housing, or apartments.

Further research is needed to determine if there is a relationship between the level of education and the level of awareness in building engineering consultants and the effect that their confidence levels have on clients.

Acknowledgements

The authors would like to thank the funding bodies for these projects, FORMAS (The Swedish Research Council for Environment, Agricultural Sciences and Spatial Planning), SSF (Swedish Foundation for Strategic Research), SBUF (Development Fund of the Swedish Construction Industry), Competitive Building, Lund Institute of Technology and JM AB. We would also like to thank all the consultants who gave their time and experience to us and all the people who have given us feedback for the improvement of this work.

References

- Arfvidsson, J. and Sikander, E. (2002). Fuksäkert byggande – Enkätstudie om kunskapsläget (Moisture-safe building – Survey of the level of knowledge) Gothenburg: FoU-Väst Report # 0205.
- Augenbroe, G. (2002). Trends in building simulation. *Building and Environment* 37, p. 891.
- Barrett, P. and Stanley, C. (1999). *Better construction briefing*. Oxford: Blackwell Science.
- Becker, R. (1999). Research and development needs for better implementation of the performance concept in building. *Automation in Construction* 8, p. 525-532.
- Blanton H., Carvalho M., DeHart T. and Pelham B. W. (2001). Overconfidence as Dissonance Reduction. *Journal of Experimental Social Psychology* 37, p. 373-385.
- Burke, S. (2003). Reducing the Risk of Failure in Performance within Buildings In: ed. Atkin, B., Borgbrant, J. & Josephson, P.-E., *Construction Process Improvement*, p. 82-92, Oxford: Blackwell Science.
- Byggandets kontraktskommité. (1996). Allmänna bestämmelser för konsultuppdrag inom arkitekt- och ingenjörsvksamhet av år 1996: ABK 96 (General rules for the consulting

profession within architectural and engineering fields from 1996: ABK 96.), Stockholm: FörlagETT, p. 4-10.

Ellis, M.W. and Mathews, E.H. (2001). A new simplified thermal design tool for architects. *Building and environment* 36(9), p. 1009-1021.

Goodings, D.J. and Ketcham, S. A. (2001). Research versus practice in transportation geotechnics: Can we bridge the chasm? *Journal of professional issues in engineering education and practice* 128(1), p. 26-31.

Hagentoft, C.-E. (2001). *Introduction to Building Physics*. Lund: Studentlitteratur.

Hien, W.N., Pho, L.K. and Feriadi, H. (2000). The use of performance-based simulation tools for building design and evaluation - a Singapore perspective. *Building and Environment* 35, p. 709-736.

Jelvefors, A. (2002). Lägenheter vattenskadade på Bo01 (Waterdamaged apartment at Bo01). In *Metro*, Malmö.

Luthander, P. (2001). Skanskas byggselarv orsakade mögel (Skanska's construction carelessness caused mould), *Dagens Nyheter*, Stockholm.

Peterson, D. K., and Pitz, G. F. (1988). Confidence, uncertainty, and the use of information. *Journal of Experimental Psychology: Learning, Memory, and Cognition* 14, p. 85-92.

Princeton University, (1997a). Wordnet 1.6 as found at <http://www.dictionary.com/search?q=consultant> accessed April 24, 2002.

Princeton University, (1997b). Wordnet 1.6 as found at <http://www.dictionary.com/search?q=engineer> accessed April 24, 2002.

Samuelson, I. and Wänggren, B. (2002). Fukt och mögelskador Hammarby Sjöstad (Moisture and mould damage Hammarby Sjöstad). Borås: Swedish National Testing and Research Institute.

Taylor, S.J. and Bogdan, R. (1998). *Introduction to Qualitative Research Methods - A Guidebook and Resource*. 3rd Edition, New York: John Wiley & Sons, Inc. p. 87-116.

Yverås, V. (2003). Performance Indicators as a Tool for Decisions in the Construction Process In: ed. Atkin, B., Borgbrant, J. & Josephson, P.-E., *Construction Process Improvement*, p. 68-81, Oxford: Blackwell Science.

7.7 Paper VII

Burke, S. Confident or cautious moisture consultant – which is best*,
Submitted to: *Building Research and Information* on September 7th, 2008

*Editor suggested a title change to: ‘The need for feedback in engineering:
moisture consultants’

**CONFIDENT OR CAUTIOUS MOISTURE CONSULTANT – WHICH IS
BEST?**

Stephen Burke

Department of Building Physics, Lund University, Box 118, 221 00 Sweden

E-Mail: Stephen.burke@byggtek.lth.se

CONFIDENT OR CAUTIOUS MOISTURE CONSULTANT – WHICH IS BEST?

Abstract

The building industry in Sweden has been struggling with increased moisture damages in recent years. This is happening, despite all the available knowledge regarding building materials and building technology. A previous study provided some insight into possible reasons why this may be occurring. This paper uses systems analysis to analyze the system used by some moisture consultants when working with moisture problems in order to determine if there is a systematic explanation for the lack of use of current knowledge. After analyzing the general system, it appears that many engineering consultants seldom follow up on their old projects. With the current system they work under, their ability with moisture issues can remain at the same level as their education thereby losing the value of experience. If a feedback component is introduced in a systematic way, e.g. knowledge management, connected to further education when needed, then experience becomes meaningful and the person's ability should increase over time and the quality of the individual's work should increase.

Keywords: moisture problems, moisture control, engineering consultants, feedback, knowledge management, systems analysis

Introduction

Moisture design is a growing trend in Sweden since the building industry has been struggling with an increase in moisture damaged buildings. There has also been much more attention from the mass media, which has taken an interest in reporting the various projects around Sweden that have suffered some kind of moisture problem. The most common failures involve mould in buildings and moisture damage in newly constructed buildings, primarily multi-family dwellings (Jelvefors, 2002, Luthander, 2001). The latest scandal in Sweden (year 2007) is related to a popular façade type of cement rendering applied directly on an insulation layer covering a wood framed wall. Traditional facades have an air space between the rain protection layer and the building envelope, which is nonexistent in this type of façade. SP Technical Research Institute of Sweden estimates that because of the popularity of this façade type, damages could be in the billions of Swedish Kronor (Brinck, 2007, Sandén, 2007, Larsson, 2008). Tolstoy (1994) has also stated that in Sweden, roughly SEK 6 billion per year is spent on repairs and maintenance of buildings and of that, approximately half goes to damages caused by moisture damage.

The involved actors have become aware that moisture problems can occur if not handled properly, however there seems to be different ideas and approaches on how to deal with the issue. There is a prevailing situation where designers/engineers, with different educational backgrounds, use their experience and different rules of thumb to damp proof different building components. Their experience is somewhat questionable as it is not documented (Burke and Yverås, 2004). Low priority and a lack of elementary knowledge of building physics seem to be the cause of poor design (Becker, 1999). On the other hand, clients are not always equipped to formulate the requirements within the contract.

An interview study by Grantén and Sikander (2003) showed that two of three developers do not specifically handle moisture design. It was taken for granted by the developers that the involved project manager would take care of that during the building process. Another study by Schultz (2003) supports this, with the conclusion that there is a lack of knowledge among the actors within the

building process, especially the clients. There are a couple of tools available in Sweden which guides consultants through the process. One is a checklist developed by Grantén and Sikander (2003) and another is Moisture Security in the Building Process (Mjörnell, 2007) which includes a method of documenting the steps taken during the moisture design of the building.

The checklist by Grantén and Sikander (2003) includes an evaluation of the designer concerning their knowledge and skills about moisture design. This is a difficult task because it is a subjective opinion and even the designers cannot agree on what is considered to be sufficient knowledge in moisture design. Burke and Yverås (2004) observed that their confidence about their own skills and awareness about moisture design seemed to be correlated to their level of education. That is, those with less education seemed to be less worried about creating a damp proof, or moisture secure, building than those with a higher education. A new study by Yverås (2008) adds an additional complication, which indicates that their ability may be more dependent on when they have received their education in building physics and not how high their level of education is.

Despite all the attention in mass media the past few years, the building industry has not changed its methods until recently, when the rendered façade problem began, in combination with the stricter building code. Now the industry must re-think past solutions. In the past, they have been able to work with ‘tried and proven’ constructions without thinking of the implications (Landin, 2000). In the future they must be able to prove that all solutions will not lead to moisture problems in the construction.

In many countries, architects are responsible for the design and detailing of a building. In the Swedish building industry it is common that the architects are only responsible for the form and shape of a building and engineering consultants are responsible for the technical specifications.

One of the big questions this paper provides some insight to is, with all the available knowledge about designing a building, how can these moisture problems still be occurring in new buildings?

Aim

Using systems analysis theory, this paper will describe the basic system that engineering consultants working with moisture problems use when working with moisture issues. This system will be analyzed in order to determine if there is a bottleneck in the system that prevents consultants from realizing their full potential. This analysis should give some insight into why the building industry keeps repeating the same mistakes and what steps may be taken by management to reduce this phenomenon.

Systems Analysis and Knowledge Management as Tools

Systems analysis refers to the science of understanding how systems function. One of the primary tools within systems analysis is a Causal Loop Diagram (CLD). A CLD is a standardized tool developed in the 1960's (Forrester, 1961) that can be used to visualise an individual's understanding of a system. Its primary advantage lies in the fact that it allows people from different disciplines to communicate ideas in a standardized way in regards to how a system functions and how one component affects other components. Using this tool, a CLD was created showing the system in which engineering consultants operate within in the building industry based on the previous experience of the authors and interviewed consultants who work with moisture problems.

Knowledge management refers to a system of how an organisation captures and re-uses project knowledge. This incorporates well known learning theories and models such as the Plan-Do-Check-Act (PDCA) cycle (Deming, 1986) which is used in ISO 9001, double-loop learning developed by Argyris et. al. (1985) and experimental learning developed by Kolb (1984). Knowledge management and more information regarding the application of learning methods within the building industry can be found in Sunding (2006) and Persson (2006).

Definition of Terms

In order to understand the system and the CLD, the key terms must be defined.

Self education/understanding of moisture theory: this refers to the level of knowledge of the engineering consultant obtained from a formal education or courses. This is their level of theory. The more theory one has, the better the chance that they understand the problem and the solutions.

Ability with moisture issues: This is the ability to apply theoretical knowledge in order to solve practical problems. It is important to note that ability is not to be confused with how good someone thinks they are with moisture problems, this refers to their actual ability. The concept of how good someone thinks that they are has been researched before and is put into the context of the Swedish construction system in Sunding (2006).

Questions: This refers to questions that may arise in dealing with a moisture problem or questions that the consultant may have.

Answers: This refers to the *correct* answers a consultant has to specific questions.

Acquire projects: This is the ability to obtain new projects.

Completed project: We assume here that each time a consultant begins a project, they complete it and add it to their merit list (CV).

Experience (years in field): Refers to the number of years that the engineering consultant has been working with moisture problems in the field. Experience also refers to their memories of their past projects and includes the past performance of chosen solutions within each project (if any).

Confidence: This refers to the confidence level of the engineering consultant in dealing with moisture problems.

Feedback from past projects or review of state of knowledge: Time allowed for the engineering consultant to review old projects (what worked, what did not work, why or why not), read literature regarding moisture theory and practise or discuss cases with other co-workers.

The System Explained and Discussed

In order to understand the results from both (Burke and Yverås, 2004) and (Yverås, 2008), which show that the ability of the engineering consultant to solve moisture problems appears to be related primarily to their level and year of education and not to their experience (years in the field), a CLD of the system in which the moisture consultant operates was developed. This CLD should be valid for all moisture consultants with different consultants utilizing different stages of the system.

Learning Stage

Let us look at the first part of the system, as shown in Figure 1, in detail. This part can be seen as the education/learning stage.

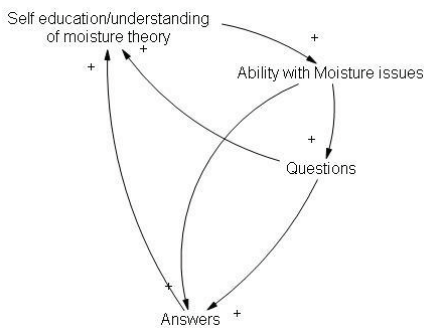

Figure 1: The learning/education phase.

The system begins with some kind of formal education on the topic of moisture theory. With more theory, the individual has more ability to deal with complex moisture problems. Sometimes the level of theory must be upgraded in order to answer questions that may arise when working with some problems. Additionally, answers provided by others can also increase theoretical knowledge. As their ability increases, the number of questions also increases because they have enough knowledge to realise the complexity of the issues. Some of their questions can be answered based on their current level of knowledge. However, sometimes more education is needed (self study via books and literature

or courses) to increase their ability with moisture issues allowing them to answer questions they may have.

Working Stage

In the next part of the system, Figure 2, the consultant begins working with moisture problems.

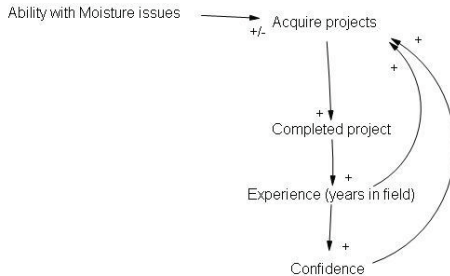

Figure 2: The applied phase where theory is put into practice.

They acquire projects based on their ability with moisture issues, their experience and even their confidence level. Their confidence level refers to how well the consultant sells themselves and how they feel about themselves. We assume that the consultants finish the projects they begin, and add them to their CV. In addition they gain experience, which refers to their memories of past projects and the number of years they have worked with moisture problems. Over time as they gain more experience their confidence level increases because they feel more comfortable that what they do and know about moisture problems is correct. This in turn increases their chances of acquiring new, more complex problems to solve.

Putting together the first two stages we get a system that is shown in Figure 3.

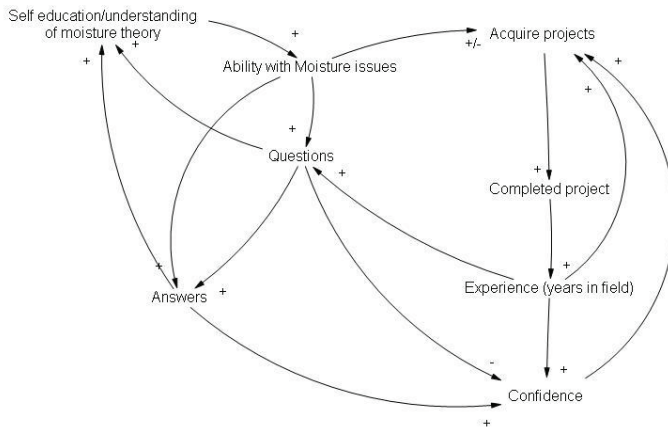

Figure 3: The combined education/learning and work phases.

In this system, there is a connection from experience to questions; this connection refers to questions that develop over time as one works longer. There is also a connection from questions to confidence showing that the more questions you have that are un-answered, the less confident the consultant is in their ability to solve moisture problems. Countering this, there is also a link showing that the more answers that the consultant has, the more confident they are.

It is suspected, based on conversations with numerous consultants, that this is the system in which moisture consultants currently work under. They complete some kind of education, and then begin working in the field. The consultants may have some questions, but they are not encouraged to answer these questions or gain the knowledge needed to understand the question. Their answers are almost always based on the information they received during their education.

As shown in Burke and Yverås (2004) and Yverås (2008), this system can prove to be disastrous. Consultants with a low level of education and a low ability with moisture issues can have a very high confidence level (as illustrated in Figure 6, Yverås 2008), convincing the client that they know a great deal about moisture problems. If this individual also has a very high experience level then most

projects they will work run a very high risk of failure. However, blame cannot be placed on the individual because this system is flawed and does not allow for them to learn from their past. They may never know which projects were good or which ones were bad. This was very apparent from the interviews conducted in Burke and Yverås (2004) when the highly educated moisture expert said they spent most of their time fixing other peoples mistakes.

A new study by Yverås (2008) complicates this observation somewhat. It was observed, from a new set of interviews that the 'moisture experts', with various levels of education and a lot of experience (i.e. old education), may not have the same ability as those with newer education and little experience. The two lowest scoring groups were those with the highest level of education and those with the most experience. Interestingly, the group of consultants with the least amount of confidence with a mid-level education out performed the other groups with less and more education. From this study it appears that perhaps even the highly educated experts with a lot of experience are being caught in the model shown in Figure 3 where they rely on their high level of education and their experience to gain new projects, without continually updating their knowledge.

This system also supports the finding from Burke and Yverås (2004) which indicated that the consultants with a Master of Science in Civil Engineering were not very confident when working with moisture issues. The explanation using this model shows that they have enough ability with moisture problems to recognize that they have a lot of un-answered questions, lowering their confidence level. In this scenario, the Civil Engineer is a much better choice of consultant compared to the experienced, confident consultant with a low ability and low level of education or, as Yverås (2008) shows, the confident expert with a lot of education. Unfortunately, assuming that the price was not an issue, most clients would choose the confident consultants because they give the illusion that they have a high ability.

Feedback Loop

The system shown in Figure 3 is due to failure because incomplete. In order for consultants to improve over time they must be allowed to seek feedback from past projects. This new system can be seen in Figure 4.

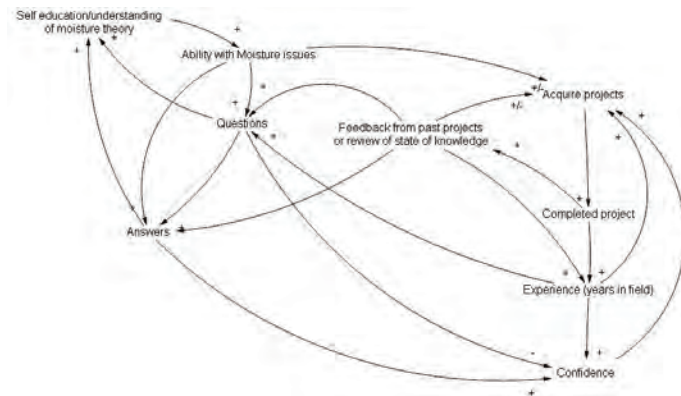

Figure 4: A proposed system of working to ensure the steady improvement of moisture consultants over time.

When the feedback component is added the consultant can make more use of their experience.

The most common version of the model shows that the consultants know what they did in the past, but do not know how those solutions performed. By reviewing past projects and acquiring feedback they know what they did in the past, and they find out if their solution worked and if not, why. Whilst this component does not directly affect their ability, it does increase the number of questions and answers they have indirectly increasing their ability. This also regulates their confidence level so that they feel confident, but not over-confident, when confronted with difficult moisture problems and they also have a better idea of their limitations.

This system is the same system used by some moisture experts within companies. One interviewed engineering consultant stated that their in-house moisture expert spent a lot of time reading reports when not working with specific projects. Unfortunately it is not used by the majority of moisture consultants because they are not allowed time to seek feedback or review current knowledge.

One source of feedback was not added to the definition of 'Feedback from past projects'. This is verbal feedback from co-workers. For example, a younger engineer might get feedback from an older, more experienced engineer. This is not included in the definition because there are too many unknowns. The most important is that it is unknown if the older engineer was caught in the previous loop without proper feedback. If that is the case, the younger engineer may actually decrease their ability with moisture issues since we have seen in Burke and Yverås (2004) and Yverås (2008) that their abilities are based on their levels and year of education! In this scenario, it is the more experienced engineer with the older education that would benefit from the newest engineer with the newest education.

Of course the opposite can also be true in regards to verbal feedback. If the more experienced engineer used a feedback system in way defined by the model, developing themselves as their career progressed, the younger engineer would greatly benefit from their knowledge of past projects. In this scenario education is not the key component. This would allow the younger engineer to develop even faster, gaining some of the ability from the more experienced engineer.

According to the model in Figure 5, in order to ensure consultants improve over time is to incorporate feedback and education into the working environment. Instead of constantly working on new projects, time must be made for reflection and review of completed projects. In Sunding (2006) it is maintained that this is not enough in situations that are potentially threatening or embarrassing, e.g. if it involves discovering inconsistencies or flaws in ones own conceptions which might invoke anxiety which will trigger psychological defence. This is also stressed by Argyris et al. (1985) who have developed a special method to deal with the defence – the double-loop-learning.

One tool that can help to ensure that consultants improve over time and get the feedback that they need is to introduce the idea of knowledge management into the organisation. Used in combination with a quality assurance program such as ISO 9000, knowledge management can help consulting engineers maintain a high level of skill with moisture problems based on recent developments in the field. This could also provide and produce documented feedback for others within the organisation to study and review.

Other Applications

This problem regarding learning and development is not limited to moisture issues. Recent research by Heylighen et al. (2007) discusses a similar issue with architects and how they are trying to encourage architects to seek more knowledge from past projects by the use of an on-line database of case projects called DYNAMO. In this case, some architects look negatively upon past cases since they do not want to be 'contaminated' by past designs in their effort to be seen as individuals.

In the case of engineers, the main problem is that there are currently no tools of this nature available and in some companies employees are not allowed to use working hours to research old projects using more traditional methods.

In Norway engineers can assess some information on different building details. They are in the form of Building Design Research Sheets, and are published by SINTEF (SINTEF, 2007). For a yearly subscription, subscribers have access to a database containing assessments regarding a number of different design solutions. These types of tools would allow engineers to check the current body of knowledge against their designs in order to determine if their detail is documented or not. This type of information is a type of feedback in the confidence loop and while it may not contribute to their understanding of moisture problems, it will give them the experience of knowing whether they were right or wrong and effect the confidence loop accordingly.

Conclusion

According to past studies, most engineering consultants working with moisture issues are not able to review past projects. Most companies want their consultants to be earning money their entire working day and are they not allowed time to review past work. This results in a consultant that is not able to constantly develop their abilities in working with moisture issues. These consultants do not have access to the latest information and have to rely on theory learned from their secondary education or courses that they have taken. This also applies for highly educated consultants (PhD level) and consultants with a lot of experience. This can inadvertently lead to systematic problems in the design and construction phases of the building process.

As seen in the CLD, one way for managers to ensure the steady development of their engineers working with moisture issues is to allow them time to actively go back and review their old projects in order to determine what did and did not work, as well as why or why not. They also need to have time to read articles or reports in regards to the current state of the art and incorporate this knowledge into their work, be it in the form of literature, computer based tools handbooks, seminars etc. By incorporating a system for engineering consultants, e.g. implementing knowledge management within the organisation, to develop their skills with moisture problems and using existing learning tools, the construction industry can avoid most moisture problems saving a lot of time and a lot of money.

References

- Argyris, C., Putnam, R. & Smith, D. (1985) *Action science: Concepts, methods, and skills for research and intervention*, San Francisco, Jossey-Bass.
- Becker, R. (1999) Research and development needs for better implementation of the performance concept in building. *Automation in Construction*, 8, 525-532.
- Brinck, Y. (2007) Fuktskador i putsade träregelväggar (Moisture damages in rendered wood-framed walls, in Swedish). *Bygginfo PM*.

- Burke, S. & Yverås, V. (2004) A Swedish Perspective on the Prevention of Moisture Problems During the Building's Design Phase. *Nordic Journal of Surveying and Real Estate Research*, 1, 102-113.
- Deming, W. E. (1986) *Out of the crises*, Cambridge University Press.
- Forrester, J. W. (1961) *Industrial Dynamics*, Boston, MIT press.
- Grantén, J. & Sikander, E. (2003) Byggherrens krav, styrning och verifiering för fuktsäker byggnad. Borås, SP Swedish National Testing and Research Institute.
- Heylighen, A., Neuckermans, H., Casaer, M. & Dewulf, G. P. M. (2007) Building Memories. *Building Research and Information*, 35, 90-100.
- Jelvehors, A. (2002) Lägenheter vattenskadade på Bo01 (Waterdamaged apartment at Bo01). *Metro*. Malmö.
- Kolb, D. (1984) *Experiential learning: experience as the source of learning and development*, New Jersey, Prentice Hall.
- Landin, A. (2000) Impact of quality management in the Swedish construction process. *Department of Construction Management*. Lund, Lund University.
- Larsson, S. (2008) Mögelskandalen kostar miljarder (Mould scandal costs billions, in Swedish). *E24*. Stockholm.
- Luthander, P. (2001) Skanskas bygglarv orsakade mögel (Skanska's construction carelessness caused mould). *Dagens Nyheter*. Stockholm.
- Mjörnell, K. (2007) Moisture Security in the Building Process (in Swedish). Lund, Lund University.
- Persson, M. (2006) Lessons Learned in Knowledge Management - the case of construction. *Construction Management*. Lund, Lund University.
- Sandén, K. (2007) Nybyggda villio svårt fuktskadade (Newly built single family dwellings badly moisture damaged). *Sydsvenskan*. Malmö.

- Schultz, E. L. (2003) Fuktdimensionering i teori och praktik. Borås, Högskolan i Borås.
- Sintef (2007) Building and Infrastructure. Oslo.
- Sunding, L. (2006) Gemensamt problemlösande och värdeskapande i byggprojekt (Common problem solving and value creation in building projects, in Swedish). *Design Methodology*. Lund, Lund University.
- Tolstoy, N. (1994) The condition of buildings. Investigation methodology and applications. Stockholm, Royal Institute of Technology.
- Yverås, V. (2008) Insights into difficulties implementing moisture design tools. *Submitted to Building Research and Information*

7.8 Paper VIII

Burke, S., Arfvidsson, J., Claesson, J., (2009) A New Algorithm to Calculate Frost Penetration under a Building during Periodic Variable Conditions, To be Submitted to: Journal of Building Physics

A New Algorithm to Calculate Frost Penetration under a Building during Periodic Variable Conditions

*Stephen Burke, Jesper Arfvidsson, Johan Claesson
Dept of Building Physics, Lund University*

KEYWORDS: Frost Penetration, Kirchhoff potential.

SUMMARY:

The paper presents a method to calculate the frost penetration under a foundation. To use this method, a new computer program called Thermoground – LTH was created. This program includes snow cover in the climate file and uses different thermal properties and latent heat of freezing when freezing and thawing of soil occurs. The program was compared to a commercial thermal simulation program called HEAT2. The results show that a variable thermal conductivity has a small effect on the results when compared to a constant thermal conductivity and the effect of snow in Northern Sweden.

1. Introduction

Most foundations in Sweden are currently, due to moisture safety and economic reasons, built as a concrete slab on the ground with thermal insulation under the slab. To make the buildings more energy efficient, the thickness of the thermal insulation has increased significantly during the last decade.

The climate in Sweden has rather cold winters with temperatures below zero even in southern parts of the country. In northern parts it can be very cold, as low as minus 10-20 °C. The combination of cold winters and increasing thickness of thermal insulation makes the risk for frost penetration under the foundation of buildings higher than before, and the risk for damages in connection with frost heave must be taken into account.

To calculate the frost penetration in a correct way it is necessary to handle the time dependant temperature field and heat flow in the ground. It is important to take into account that the thermal conductivity and volumetric heat capacity in the ground are different for different soils and that they change when the ground temperature is below zero. The effects of latent heat may also be important.

There is currently one commercial tool available as a part of a geological tool package which is able to simulate the effect of latent heat under buildings and around pipelines (GEO-SLOPE, 2008). However, this tool is expensive. Considering the concerns discussed in previous research where consultants feel tools are too expensive, a cheaper tool was needed. (Hien et al., 2000, Ellis and Mathews, 2001)

The next-best tools currently available to consultants for solving this type of problem are the HEAT-series programs (Blomberg, 1996). They are popular software commercially available for solving two and three dimensional thermal simulation problems and are not excessively expensive. Because of the complexity of this problem, an easy-to-use tool is wanted by the industry to be able to minimize the risk of damages.

Roots and Hagtoft (2006) have developed an easy-to-use model based on the shape of the frost penetration isotherm. They show that by placing insulation under the ground and away from the building, it is possible to move the frost penetration isotherm so that it does not go under the foundation. However, it is unknown if this model has taken into account snow cover. According to Roots and Hagtoft, only outdoor temperature is used as the driving force determining frost penetration.

2. Calculation model

The model presented uses the Kirchhoff potentials to describe the nonlinear heat transfer. This simplifies the model considerably. A short description of the Kirchhoff potentials is given below.

2.1 Kirchhoff potential

Let q denote the heat flow and T the temperature. In the one-dimensional case we have:

$$q = -\lambda(T) \frac{\partial T}{\partial x} \quad (1)$$

Here the flow coefficient, λ , depends on T . Kirchhoff originally introduced his flow potential, when the flow coefficient is a function of the state (Carslaw & Jaeger, 1959, pp 11). This potential is defined by:

$$T_\lambda(T) = \frac{1}{\lambda_{ref}} \cdot \int_{T_{ref}}^T \lambda(T) dT \quad (2)$$

The reference values λ_{ref} and T_{ref} can be chosen arbitrarily for each material. We normally, by convenience, put the value of T_λ to zero for a reference level T_{ref} for the material: $T_\lambda(T_{ref}) = 0$. The heat flow (1) now becomes:

$$q = -\lambda_{ref} \frac{\partial T_\lambda}{\partial x} \quad (3)$$

The variable thermal coefficient $\lambda(T)$ is replaced by a constant λ_{ref} .

2.2 Theory for determination of the frost penetration in the computer program Thermoground - LTH

A two-dimensional computer code was used for the calculations. This code was originally developed for moisture calculations with nonlinear transport coefficients and therefore can

advantageously be used to calculate the frost penetration. The program solves the heat balance equation numerically with an explicit forward-difference method. In the program the construction and soil is divided into a number of calculation cells. Each material is specified geometrically. Material data in form of heat conductivity, λ (W/m-K), and heat capacity, C (J/m³K), are given for the materials as functions of the temperature.

In the calculations homogeneous soil is assumed and its heat content E (J/m³) is a function of temperature. At temperature 0°C the heat content is by definition zero. Soil is assumed to freeze within a range $T_f \leq T \leq 0$. In any calculation cell in the ground there are three possibilities: completely frozen, freezing and completely unfrozen. The lower freezing limit T_f can be chosen freely. In these calculations T_f is -1°C. If the ground reaches the completely frozen state from the fully unfrozen state, the latent heat L (J/m³) must be released. The heat content has fallen to $-L$ when the temperature reaches the bottom frozen limit T_f . Figure 1 shows the heat content E as a function of temperature. Phase transitions occur over a temperature range where the heat capacity is significantly larger than in frozen and unfrozen ground. Heat capacity is $-L/T_f$, which is the slope of the curve in the freezing state. For the completely unfrozen and frozen states, the soil is characterized by constant heat capacity C_u and C_f . (Efring, 1991)

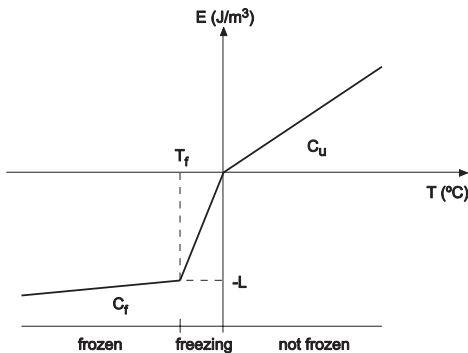

Figure 1: Temperature-dependent thermal capacity model for Thermoground - LTH.

2.3 Calculating a slab on the ground foundation

The program Thermoground - LTH has been used to calculate the frost penetration under a slab-on-the-ground foundation for three locations in Sweden. These results are compared to a popular commercial thermal simulation tool, HEAT2, using the same climate and material data.

Outdoor temperature is chosen as a sinusoidal variation:

$$T_{out} = T_{mean} + T_{amplitude} \cdot \sin \left[\frac{2\pi(t_{day} - t_{phase})}{t_{period}} \right] \quad (8)$$

where:

T_{out}	calculated temperature outside for actual day
T_{mean}	yearly mean temperature
$T_{amplitude}$	seasonal variation of the outdoor temperature
t_{day}	actual day
t_{phase}	phase change in time
t_{period}	seasonal periodic variation

During mid-winter a cold period with the added temperature T_- (as shown in Figure 2) is included over 5 days in Thermoground - LTH.

The following climatic data is assumed for the calculation cases:

A. South of Sweden

$$T_{out} = 7 + 8.5 \cdot \sin \left(\frac{2\pi(t_{day} - 113.5)}{365} \right) \quad T_- = -15 \text{ }^\circ\text{C}$$

B. Mid Sweden

$$T_{out} = 6 + 10 \cdot \sin \left(\frac{2\pi(t_{day} - 113.5)}{365} \right) \quad T_- = -15 \text{ }^\circ\text{C}$$

C. North Sweden

$$T_{out} = -1 + 13 \cdot \sin \left(\frac{2\pi(t_{day} - 113.5)}{365} \right) \quad T_- = -15 \text{ }^\circ\text{C}$$

An example of the outdoor temperature for the calculation case A is shown in Figure 2.

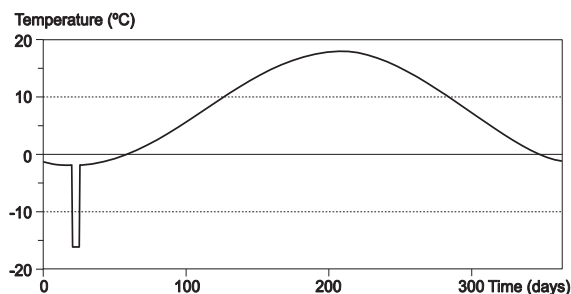

Figure 2: Used temperature for the south of Sweden.

Figure 3 shows the dimensions of the slab on the ground used in the simulations. The building is 6 m wide, has a 0.1 m thick concrete slab with 0.1 m of insulation under the slab. The indoor temperature was 22°C.

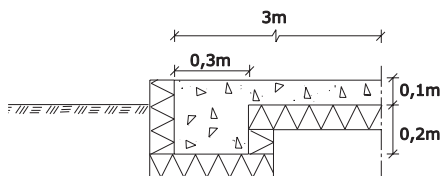

Figure 3: The geometry for the simulations using Thermoground - LTH and HEAT2.

Table 1 shows the material properties used in the simulations. In the table, λ_u is the unfrozen thermal conductivity, λ_f is the frozen thermal conductivity, C_u is the unfrozen thermal capacity and C_f is the frozen thermal capacity. One simulation was done with a constant thermal conductivity and little latent heat of melting/freezing in order to determine the effect of a temperature-dependant thermal conductivity compared to a constant thermal conductivity.

Table 1: Data used in the simulations. *HEAT2 only used the unfrozen values.

Material	λ_u (W/m-K)	C_u (J/m ³ K)	λ_f (W/m-K)	C_f (J/m ³ K)
Concrete	1.7	2208000	1.7	2208000
EPS30	0.033	37500	0.033	37500
Dry crust clay with silt*	1.4	2700000	2.6	1850000

3. Results and Discussion

The results, using the described method, are shown in Figures 4 to 10. The temperature is the temperature under the edge of the concrete. In all cases the chosen thickness of insulation is thin enough to prevent frost penetration under the foundation, even during the 2nd year after construction. The reason for focusing on year two is that a foundation has the highest risk of frost penetration during the first year. Since we do not know the actual time of construction the second year is recorded. The results for year 11 are also used since by this time an adequate thermal cushion has developed under the building and it should be stable by this point in time. The HEAT2 results show the max and min temperatures under the edge of the concrete. When using HEAT 2, it shows that the insulation is too thick to prevent frost penetration in Kiruna. Unfortunately, when looking at the results after 11 years, HEAT 2 shows permafrost in the ground. According to geological surveys of frost depth around this region, the frost only penetrates 1.5 to 2 meters and there is no permafrost in this geographical area.

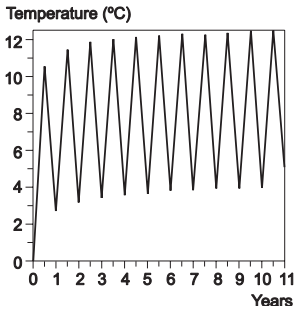

Figure 4: HEAT 2 results with Stockholm climate (mid Sweden).

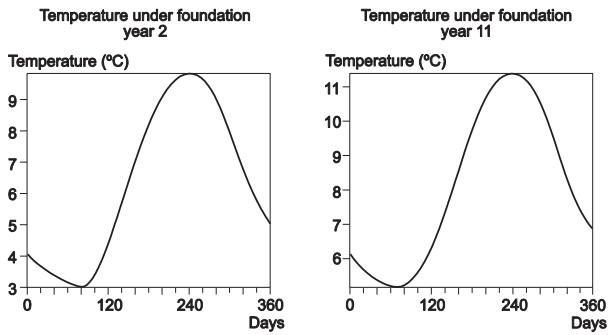

Figure 5: Thermoground - LTH results with Stockholm climate (mid Sweden) for years 2 and 11.

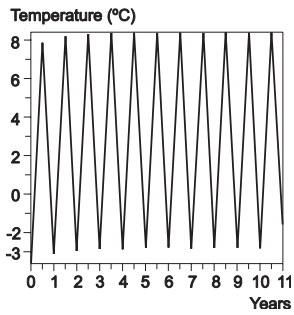

Figure 6: HEAT 2 results with Kiruna climate (North Sweden).

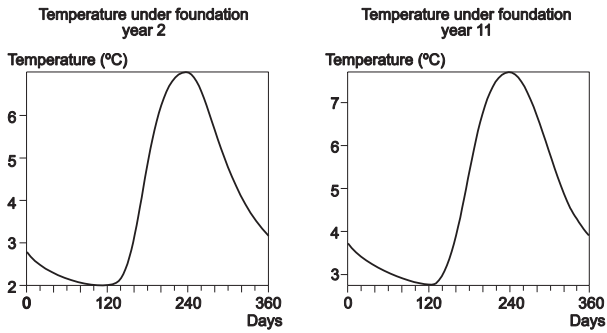

Figure 7: Thermoground - LTH results with Kiruna climate (North Sweden) for years 2 and 11.

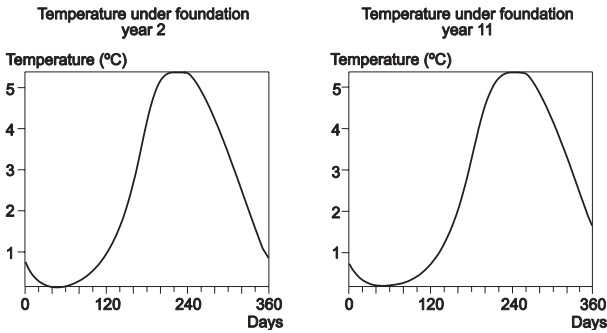

Figure 8: Thermoground-LTH results with Kiruna climate using a constant thermal conductivity.

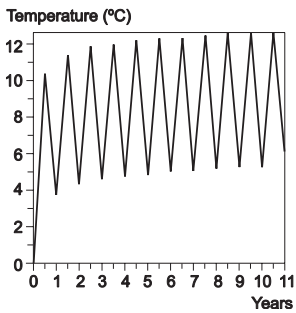

Figure 9: HEAT 2 results with Malmö climate (South Sweden).

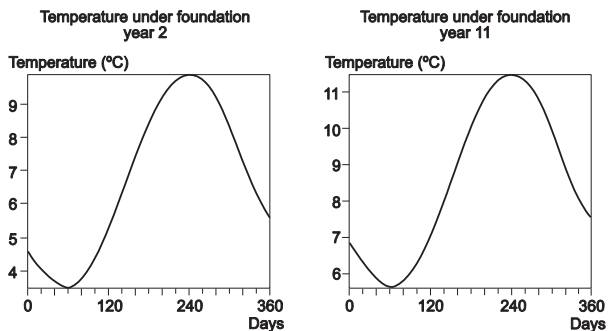

Figure 10: Thermoground - LTH results with Malmö climate (South Sweden) for years 2 and 11.

The reason for the difference in results is that Thermoground - LTH takes into account snow cover in the climate file. While there is no snow simulation model within the program, the climate file has monthly average snow resistance values which become a surface resistance for the boundary of the soil exposed to the outdoor climate. This surface resistance is calculated using the average snow thickness for the month with an average heat flow coefficient for snow, in this case 0.3 W/m·K. This version of HEAT 2 is not able to have a time varying surface resistance representing the layer of snow.

It was possible to determine the effect a temperature-dependant thermal conductivity has on the final result of the simulation by setting the soil's thermal conductivity to be constant, Figure 8. The results of this show that by taking into account variable thermal conductivity, the minimum temperature under the edge of the foundation was increased by 2°C in Kiruna.

The most important result from this study is that snow cover must be taken into account when determining frost penetration under buildings using thermal simulation software. If this is not possible with the thermal simulation program, then the results will be incorrect and the optimal amount of insulation will not be used, thus resulting in a building which uses more energy than necessary. Some future modifications for Thermoground – LTH should be the addition of insulation away from the foundation as per Roots and Hagentoft (2006). With this option it should be possible to optimise both the thickness of the insulation under the building, and the amount of insulation going away from the building to allow for the most energy efficient building possible for cold climates.

4. Conclusions

A technique for determining the frost penetration under a building is presented. It can be concluded that the variable thermal properties had a small impact on the results by increasing the temperature under the foundation. It can also be concluded that snow cover around a building must be taken into account when simulating frost penetration under a building. If a

simulation tool is used to determine the frost penetration and it cannot take into account snow or a variable surface resistance, the results will be incorrect.

5. References

- Blomberg, T. (1996) Heat conduction in two and three dimensions - computer modelling of building physics applications. Department of Building Technology, Building Physics. Lund, Lund University.*
- Efring, B. (1991) Numerical calculation of thermal processes. A physical approach (In Swedish). Lund, Building Science.*
- Ellis, M. W. & Mathews, E. H. (2001) A new simplified thermal design tool for architects. Building and Environment, 36, 1009-1021.*
- Geo-Slope (2008) Thermal Analysis with TEMP/W. Calgary, Alberta, Canada, GEO-SLOPE International Ltd.*
- Hien, W. N., Pho, L. K. & Feriadi, H. (2000) The use of performance-based simulation tools for building design and evaluation - a Singapore perspective. Building and Environment, 35, 709-736.*
- Roots, P. & Hagentoft, C.-E. (2006) New design model for frost protection of a slab on grade. IN FAZIO, P., GE, H., RAO, J. & DESMARAIS, G. (Eds.) Research in Building Physics and Building Engineering. London, Taylor & Francis Group.*

7.9 Paper IX

Burke, S., Claesson, J. & Arfvidsson, J. (2008) A New Method of Determining Moisture Flow Coefficients for both Isothermal and Non-isothermal Conditions. IN RODE, C. (Ed. *Proceedings of the 8th Symposium for Building Physics in the Nordic Countries*. Kgs. Lyngby, Denmark, Dept. of Civil Engineering, Technical University of Denmark.

A New Method of Determining Moisture Flow Coefficients for both Isothermal and Non-isothermal Conditions

*Stephen Burke, Tekn Lic.,
Building Physics, Lund University
Stephen.Burke@byggtek.lth.se*

*Johan Claesson, Professor,
Building Physics, Lund University
Johan.Claesson @byggtek.lth.se*

*Jesper Arfvidsson, Professor,
Building Physics, Lund University
Jesper.Arfvidsson@byggtek.lth.se*

KEYWORDS: *isothermal, non-isothermal, moisture transport, experimental, phenomenological.*

SUMMARY:

The calculation of isothermal moisture transport requires a moisture flow coefficient, $D_{\phi}(\phi, T)$, for isothermal flow with ϕ as the moisture state variable. In the non-isothermal case, a second flow coefficient, $D_{T\phi}(\phi, T)$, is required to account for the temperature gradient. This means that a number of isothermal measurements are required for a few different temperature levels. It also means that a corresponding second set of measurements with temperature gradients are required.

This paper presents a new method of determining these flow coefficients for a set of moisture states and temperature levels. This is accomplished by measuring the change in mass over time as the sample absorbs or desorbs moisture. The sample is sealed and thermally insulated on all but one side with a heating pad at the top of the sample (within the insulation). This assembly is hung from a balance in a climate box that has a controlled temperature and relative humidity. The sample is exposed to a step-wise change in relative humidity and the change in mass over time is recorded. Care is taken to ensure that the sample is either absorbing or desorbing moisture in order to avoid complications with hysteresis. In the isothermal case, the sample is kept at a constant temperature during the measurements. In the non-isothermal case the sample has a known temperature gradient set by the temperature of the heating pad and the temperature of the climate box. The moisture flow coefficients are obtained from an analysis of the transient changes in mass.

The method and the ideas upon which it is based are presented. A few preliminary results, and technical difficulties encountered during the experimental development, are reported.

1. Introduction

1.1 Background

As buildings become more energy efficient, moisture management plays a more significant role in determining the performance of the building envelope. Without a proper understanding of moisture transport theory and the associated data, simulating different situations will be very difficult and could lead to unexpected moisture problems within a building envelope due to the lack of information. These problems can have a negative impact on both the structural integrity of the building and/or the health of the occupants (Bornehag et al., 2002, Fisk, 2000, Hägerhed et al., 2002, Nevalainen et al., 1998).

Moisture transport in materials is a complex phenomenon that has been studied quite a lot since the 1950s. Today's modern theory of moisture transport began with Philip and DeVries (1957) when they developed a theory of moisture transport which divided the total flow into liquid and water vapour flow and described this flow by equations involving gradients of moisture state and temperature. The difficulty with non-isothermal moisture transport is that it is impossible to directly measure the separate flows; only the sum is measurable.

Other experiments have been designed to try and quantify each effect independently through a combination of monitoring moisture transport through a material with salt solutions using a combination of isothermal and non-isothermal experiments (Arfvidsson and Cunningham, 2000, Avramidis and Siau, 1987, Bogoslovskii, 1965, Hedenblad, 1996, Li et al., 2006, Siau, 1985, Galbraith et al., 2000, Galbraith et al., 2004, Galbraith et al., 1998, Glass, 2007, Carmeliet and Roels, 2001, Segerholm, 2007).

The proposed method and experimental procedure is based on Arfvidsson (1990), Arfvisson and Cunningham (2000) and Segerholm (2007). Here, the method is presented. A few results and problems encountered in the ongoing experimental development are also reported.

1.2 Calculation of moisture flow – a phenomenological approach

The calculation of moisture flow processes in porous materials requires knowledge of equilibrium relations and equations for the moisture flux. Examples of equilibrium relations are Kelvin's equation and the relations between moisture content and relative humidity (sorption isotherm) or pore water pressure (water retention curve). These must be determined from measurements. The relation for moisture flux must also be determined experimentally. This is the key challenge, in particular for non-isothermal cases, when both moisture state and temperature vary in space and time.

First, consider the isothermal case. The generally accepted approach is to use a Fickian relation (1) between the moisture flux g and the gradient of the moisture state variable φ , which could be for example relative humidity or moisture content. The moisture flux is proportional to the gradient with a moisture flow coefficient D_φ as coefficient of proportionality. The basis for this kind of relation is the following. Consider a (thin) slab of a material with the moisture states φ_1 and φ_2 on the two sides. The flux is zero for equal moisture states, and it is reasonable to assume that the flux is proportional to the difference $\varphi_1 - \varphi_2$ and inversely proportional to the slab thickness. This gives a Fickian moisture flow equation. It is clear that the coefficient, in general, varies with the level of the moisture state and with the temperature: $D_\varphi = D_\varphi(\varphi, T)$. This coefficient must be measured for different φ and for different temperatures. Fick's law is a *phenomenological* relation that is based on direct measurements:

$$g = -D_\varphi(\varphi, T) \cdot \frac{\partial \varphi}{\partial x} \quad (1)$$

Now consider the non-isothermal case. The moisture state *and the temperature* may now be different on the two sides of the slab. The direct generalization of Fick's law is to assume that the flux has an additional term that is proportional to the temperature difference and inversely proportional to the slab thickness. The generalization of Fick's law is then:

$$g = -D_\varphi(\varphi, T) \cdot \frac{\partial \varphi}{\partial x} - D_{T\varphi}(\varphi, T) \cdot \frac{\partial T}{\partial x} \quad (2)$$

This is again a phenomenological relation that should be based on direct measurements. There are now two flow coefficients which are functions of the moisture state φ and the temperature T . It is important to realize that these two functions must be determined experimentally. There are, to our best knowledge, no general theories or relations that make it possible to avoid direct measurements. The above discussion is presented in more detail in Segerholm (2007, Ch. 7).

The required measurements are quite extensive. The isothermal flow coefficient $D_\varphi(\varphi, T)$ must be determined as a function of φ for different temperature levels. This requires isothermal measurements for a number of temperature levels. The determination of the second flow coefficient $D_{T\varphi}(\varphi, T)$ requires a corresponding second set of measurements for which there is also a temperature gradient over the slab. In the second set of measurements, the first right-hand ("isothermal") part in (2) must be known in order to determine $D_{T\varphi}(\varphi, T)$ for any particular φ and T . This means, for example, that an attempt to measure non-isothermal coefficients without knowing the temperature dependence for $D_\varphi(\varphi, T)$ may be questioned. These problems are discussed in further in Segerholm (2007, Ch. 7).

2. Description of the measurement method

The measurements for the isothermal and non-isothermal coefficients are done in different experimental set-ups. The isothermal moisture transport coefficient, $D_{\phi}(\phi, T)$, is determined in the following way. The sample is exposed to a sequence of relative humidity steps as shown in Figure 1. The change in mass over time of a small sample is recorded using a DVS 1000 sorption balance using the methods presented in Arfvidsson (1990) and Anderberg & Wadsö (2005). The figure shows the result for Norway Spruce at 30°C. Thus information is obtained regarding the moisture transport when the sample's relative humidity changes from one level to another, e.g. from 50% to 75%. Using this data, moisture transport coefficients can be calculated for each level of relative humidity at the current temperature. One phenomenon not investigated here is hysteresis, which is avoided by ensuring pure absorption or desorption.

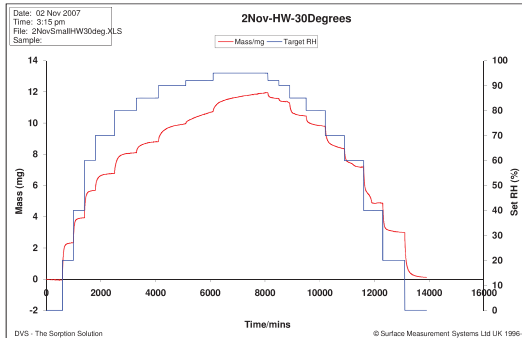

Figure 1: Data obtained from the DVS 1000 sorption balance for a 0.0529 g dry mass sample of heartwood from a Norway Spruce tree from Växjö, Sweden.

The non-isothermal moisture transport coefficient, $D_{T\phi}(\phi, T)$, is calculated by a modified weighing method. The sample is conditioned to a predetermined moisture level and sealed so that drying occurs in one direction. A temperature gradient is applied to the sample and the total moisture flow (g) over time is recorded for this temperature gradient and relative humidity in the climate box. After the sample is at steady state, the humidity is changed by changing the salt solution, and the total flow is measured again. This step is repeated for a third relative humidity, etc. The entire procedure is repeated for different temperatures. It is now possible to calculate $D_{T\phi}(\phi, T)$ for the specific sample being tested at the specific temperature and humidity range. Here, the isothermal coefficient and the measured temperature gradient are used. The precise evaluation procedure will be reported elsewhere.

This new method of measuring the non-isothermal moisture flow coefficient is based upon the idea of drying or wetting a material by applying a temperature gradient over the sample. The experimental set-up involves two parts. The first part, shown in Figure 2, is an insulated sample holder with a heating pad. The sample holder is made of Styrofoam insulation, aluminium and the System Platon sealing tape, which does not absorb any significant amounts of moisture. The sealing tape was tested in the sorption balance and absorbed approximately 0.4 mg/5000 mg sample of sealant from 0 to 95% RH. The sample holder is connected to a regulator with a sensor that ensures that the temperature at the top of the sample remains relatively constant, within $\pm 0.1^\circ\text{C}$ of the set temperature. This sample holder system is hung from a balance down into the climate box, Figure 3. A sample, which is sealed on all but one side, is inserted into the sample holder.

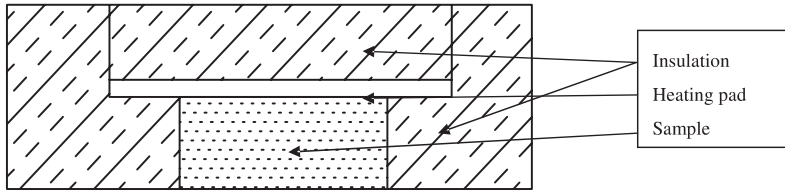

Figure 2: Cross section of sample holder.

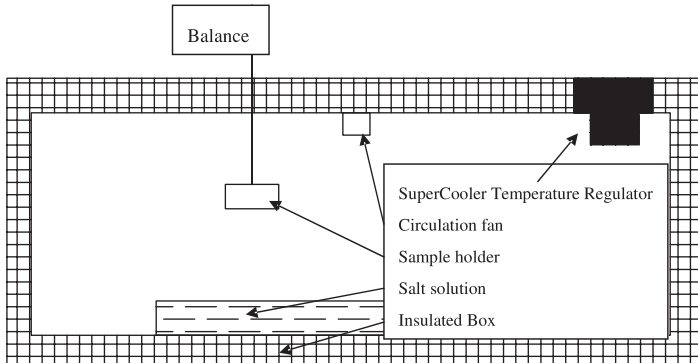

Figure 3: Section of the experimental apparatus with the sample holder hanging freely from a balance within the climate box.

The second part is an insulated climate box (Figure 3), which has a saturated salt solution at the bottom of the box, a circulation fan at the top of the box and a Supercool AA-024 thermoelectric air to air system with a PR-59 temperature controller. The AA-024 has both cooling and heating capacity with an accuracy of $\pm 0.01^\circ\text{C}$. When the system is running, the temperature varies $\pm 0.02^\circ\text{C}$ from the set point. Figures 4 and 5 show photos of the two parts of the setup.



Figure 4: The left image shows the sample holder with a sample in the center. The right image shows the control units with the sample holder to the right.

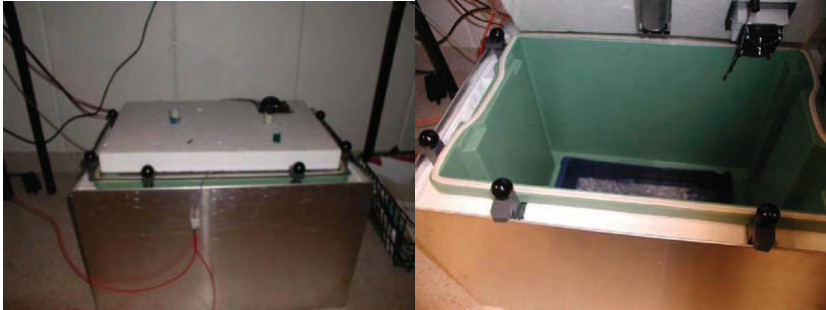

Figure 5: The insulated climate box with circulation fan, thermal regulator and salt solution.

3. Preliminary results and discussion

3.1 Isothermal moisture transport

The preliminary results for the isothermal component at the time of writing are incomplete due to the poor performance of the DVS1000 sorption balance. Only two of the minimum three complete runs were obtained between August 2007 and December 2007 for 20°C and 30°C. Each run took approximately 10 days. At 40°C condensation occurred in the sample chamber at 92% RH. The specifications of the DVS 1000 state that samples can be tested up to 95% RH at 60°C. It has been determined that the machine cannot properly condition the temperature of the sample's supply gas flow due to poor insulation in the climate chamber. The DVS is currently being modified and measurements will be re-done.

3.2 Non-isothermal moisture transport

3.2.1 Thermal analyses

When doing non-isothermal measurements, it is important that there is a one-dimensional temperature profile through the sample (with essentially straight horizontal isotherms as shown in Figure 6). Segerholm (2007) measured the surface temperature of his cup method samples and had problems with decreased temperatures around the outer edges. He minimized this effect by mounting the samples high on a plastic cup, which decreased the difference between the max and min top surface temperatures to about 0.5°C. However there are no temperatures recorded for the bottom surface where the isotherms would be cutting through the sample the most, hence having the greatest temperature variation. This temperature decrease around the outer perimeter of the samples using a cup method has also been confirmed through simulations.

Using HEAT2 (Blomberg, 1996), three-dimensional cylindrical thermal simulations were done in order to determine the optimal sample size and position compared to the heating pad and insulation thickness. In particular, the diameter of the sample was varied. The optimal case is shown in Figure 6.

An Infra Red (IR) camera was used to compare the actual thermal performance of the sample holder to the thermal simulation (Figure 7). The heating pad was set to 30°C and the indoor air temperature was 22°C. Both showed the sample to have a surface temperature of 26°C confirming the accuracy of the simulation.

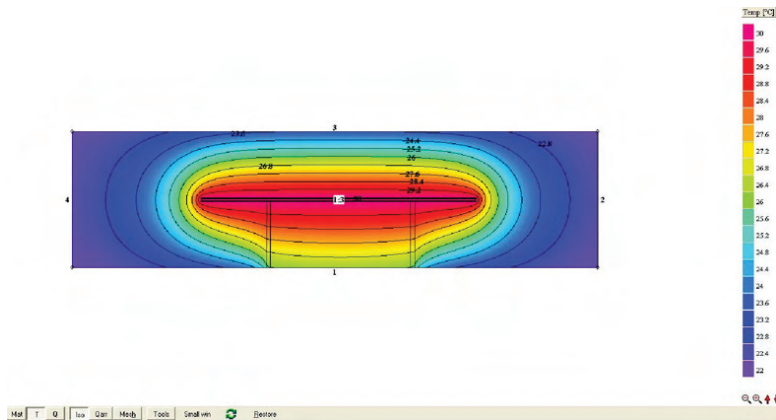

Figure 6: Optimal sample diameter to minimize the curvature of isotherms in the sample.

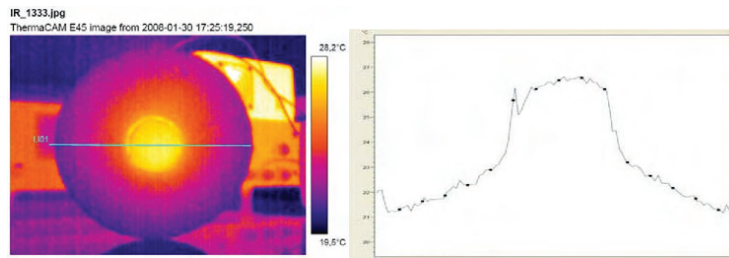

Figure 7: Left: IR image of the sample's surface. Right: The temperature profile along the width of the sample holder.

The thermal environment of the climate box is also an important factor. Any deviations in temperature can change the RH. Temperatures within the climate box have proved to be very stable ($\pm 0.2^\circ\text{C}$ from the set point) so far. The temperature control system is able to compensate for any heat from the sample holder, fans, and climate outside of the climate box, to ensure a constant temperature. This also helps to ensure that RH from the salt solution remains fairly constant. The box is not affected by a slightly different environment outside of the box, so it is not necessary to place the climate box within a climate room. However there is a point where the heat losses/gains from an extreme exterior climate will be too great for the small system to handle. One test showed that the AA-024 can cool the interior of the climate box 10°C below the external temperature of the box while maintaining a stable internal temperature. If a greater temperature difference is desired, then a larger regulator should be used.

3.2.2 Problems with moisture control

Saturated salt solutions have been used as a means of controlling humidity for a long time and there are many salts to choose from (O'Brien, 1948). However, it can be difficult to control the humidity of a closed space as a number of factors can change the humidity level. Temperature is one of the primary factors determining humidity. Thermal layering in, for example, jars can cause differences in relative humidity. This can be minimised by the use of a circulation fan. A quick test was done to see if a noticeable effect could be seen on the RH in the empty climate box with and without a fan using an old, unknown salt solution. The RH decreased by around 5% with a fan on compared to no fan. This same effect was observed by Martin (1962), while running experiments with NH_4NO_3 and a sample. He did not investigate this further and concluded that the absorption of moisture by the sample lowered the equilibrium humidity level in the jar by about 4% RH when the fan was on.

A new supersaturated salt solution of $\text{MgCl}_2 \cdot 6\text{H}_2\text{O}$ was prepared at 100°C and the experiment was repeated. No change in RH was observed. This check will be done for each salt type used since it is not known if this effect is a result of the type of salt used, the quality of the salt solution, the method in which it was prepared or leaks in the climate box.

Leaks in the system are a source of error. They have no direct effect on the mass of the sample however they can cause instability with temperature and especially RH. In this case, the thermal regulator can compensate for leaks. However, salt solutions cannot compensate for leaks. In the preliminary runs, the salt $\text{MgCl}_2 \cdot 6\text{H}_2\text{O}$ was stable in an empty climate box at around 33.7% RH, which was expected. Unfortunately the preliminary run using K_2SO_4 only had an RH of 90%, which should be 97%. During both tests, the room temperature was 21°C and the RH was 30%. It is unknown if the problem is due to the salt solution or leaks in the climate box.

3.2.3 The sample holder

During a weighing, all fans in the climate box are shut down for about 20 seconds since the fans create a wind current within the climate box which is strong enough to affect the mass of the sample and sample holder. All data are recorded just before the fans start up again so that there is no interference from air flows within the box.

The wiring connecting the heating pad and temperature sensor to the regulator from the sample holder has proven to be problematic. During preliminary measurements, it was observed that the mass showed by the balance changed if the climate box was moved. In this case, the wires were connected to a clamp on the box, and then went to the regulator that was mounted on the cover of the climate box. A second run without the clamp, allowing the wires to hang freely from the sample holder to the regulator, showed a significant improvement. The mass did not change after adjusting the climate box. However, to reduce the error as much as possible, the whole system cannot be disturbed once the measurements have started as any movement of the wire position can potentially change the mass reading.

3.2.4 Planned experimental work

It is important to remember that the work presented here is not complete. Modifications are needed to improve this method and reduce errors. Errors were even discovered with the well proven sorption balance, errors that may not have been discovered running traditional analyses at one temperature.

It is also important to note that the method will have to be repeated for the other moisture flow directions. In the case above, the moisture transport is in the fibre direction. The entire method must be repeated for both the tangential and radial directions for the same sample in order to be able to calculate the total moisture flow in all directions.

More modifications to the method must be done in order to reduce leakage and to ensure a more stable humidity level inside the climate box before full-scale experiments can be run.

4. Conclusions

The method presented here is not complete but it shows potential. It should provide the isothermal and non-isothermal coefficients, $D_\phi(\phi, T)$ and $D_{T\phi}(\phi, T)$, with reasonable resolution in ϕ and T . This would allow for moisture transport simulations based on data where the flow coefficients are directly measured.

Preliminary results thus far show the non-isothermal apparatus is very stable in regards to thermal performance and functions according to simulations run during the design of the method. The temperature control system in combination with the insulation around the climate box is able to maintain a very stable temperature. The moisture control also functions well at a low RH. Unfortunately the moisture state is not yet stable at a high RH level. At the time of writing, it is unknown if this is due to leaks in the climate box, poor quality salt solutions or other effects.

Isothermal measurements with the DVS 1000 are very precise and relatively quick. It has a closed system that reduces external errors. Once it is repaired, it should be a fast, automated method of determining the isothermal moisture transport coefficients for a large number of humidity steps at different temperatures.

5. References

- Anderberg, A. & Wadsö, L. (2005) Method for simultaneous determination of sorption isotherms and diffusivity of cement based materials. *Proceedings of the 7th Symposium on Building Physics in the Nordic Countries*. Reykjavik, Iceland, The Icelandic Building Research Institute.
- Arfvidsson, J. (1990) PC-MODELS FOR COMBINED HEAT AND MOISTURE FLOW IN BUILDING MATERIALS - Basic flow equations and required measurements. IN THUE, J. V. (Ed. *Building Physics in the Nordic Countries*. Trondheim, Tapir Publishers.
- Arfvidsson, J. & Cunningham, M. (2000) A transient technique for determining diffusion coefficients in hygroscopic materials. *Building and Environment*, 35, 239-249.
- Avramidis, S. & Siau, J. F. (1987) Experiments in nonisothermal diffusion of moisture in wood. *Wood Science and Technology*, 21, 329-334.
- Blomberg, T. (1996) Heat conduction in two and three dimensions - computer modelling of building physics applications. *Department of Building Technology, Building Physics*. Lund, Lund University.
- Bogoslovskii, V. N. (1965) The Moisture Potential. *Inzhenerno-Fizicheskii Zhurnal*, 8, 216-222.
- Bornehag, C. G., Sundell, J., Hägerhed, L. & Janson, S. (2002) Dampness in buildings and health. Dampness at home as a risk factor for symptoms among 10 851 Swedish children (DBH-step 1). Monterey, USA.
- Carmeliet, J. & Roels, S. (2001) Determination of the Isothermal Moisture Transport Properties of Porous Building Materials. *Journal of Thermal Envelops and Building Science*, 24, 183-209.
- Fisk, W. J. (2000) Review of health and productivity gains from better IEQ (Indoor Environmental Quality). Helsinki.
- Galbraith, G. H., Guo, J. S. & Mclean, R. C. (2000) The effect of temperature on the moisture permeability of building materials. *Building Research and Information*, 28, 245-259.
- Galbraith, G. H., Kelly, D. J. & Mclean, R. C. (2004) Moisture permeability measurements under reduced barometric pressures *Materials and Structures*, 37, 311-317.
- Galbraith, G. H., Mclean, R. C., Gillespie, I., Guo, J. & Kelly, D. (1998) Nonisothermal moisture diffusion in porous building materials. *Building Research and Information*, 26, 330-339.
- Glass, S. V. (2007) Measurements of Moisture Transport in Wood-Based Materials under Isothermal and Nonisothermal Conditions. *Buildings X*. Florida, USA, ASHRAE.
- Hedenblad, G. (1996) Moisture permeability of some porous building materials. *Building Physics in the Nordic Countries*. Espoo, Finland.
- Hägerhed, L., Bornehag, C. G. & Sundell, J. (2002) Dampness in buildings and health. Building characteristics as predictors for dampness in 8681 Swedish dwellings. Monterey, USA.
- Li, X., Zhang, B., Li, W. & Li, Y. (2006) Nonisothermal moisture movement in wood. *Front. For. China*, 348-352.
- Martin, S. (1962) The control of conditioning atmospheres by saturated salt solutions. *J. Sci. Instrum.*, 39, 370-372.
- Nevalainen, A., Vahteristo, M., Koivisto, J., Meklin, T., Hyvärinen, A., Keskikarhu, J. & Husman, T. (1998) Moisture, mold and health in apartment homes. Gävle, Sweden.
- O'brien, F. E. M. (1948) The Control of Humidity by Saturated Salt Solutions. *J. Sci. Instrum.*, 25, 73-76.
- Philip, J. R. & De Vries, D. A. (1957) Moisture Movement in Porous Material under Temperature Gradients. *Transactions, American Geophysical Union*, 38.
- Segerholm, I. (2007) Moisture Transport Processes in Scots Pine - Anomalous Capillary Suction. Nonisothermal diffusion. *Division of Building Technology - Building Materials*. Göteborg, Sweden, Chalmers.
- Siau, J. F. (1985) Nonisothermal moisture diffusion experiments analyzed by four alternative equations. *Wood Science and Technology*, 19, 151-157.

8 Appendix II – Interview Questions

Key Question: How would you describe the design process of a building?

Design Process

- 1) How much time is spent evaluating buildings? (Moisture, lifetime calculations, energy use, thermal comfort, IAQ, ventilation etc...) key: to determine the level of importance of these issues.
- 2) How much time would you like to spend? Key: are they even aware of the issues or are they restricted in some way?
- 3) Hindrances? Key: Describing the restrictions.
- 4) How are the various aspects integrated to get the whole picture? Key: determine if there is any form of co-operation between the different consultant groups.
- 5) If you had more money on a project for the evaluation phase, where would you spend it? Why? (Get them to elaborate on the answers.) Key: To see if they are aware of the bp aspects. Do they really think it is important?

Key Question: What are the most important performance requirements when designing a building?

Performance Requirements

- 1) What performance requirements do you have and how do you check that they are evaluated? Key: Shows if they use the performance concepts at all.
- 2) Do the customers have specific requirements? Key: Shows the level of knowledge of the clients.
- 3) Are most clients experienced the construction industry? Key: Do the clients experienced with the construction industry skip over the consultants?

4) Does the consultant ask the clients about other requirements (above the minimum required by law)? Key: Shows if they understand performance concepts.

5) Has the clients ever suggested any other solutions that the consultants disagreed with? Key: How have they dealt with such clients? How do they show client's their mistakes in the design of the building? Do they even point out flaws if the client has approved/designed the design?

6) Do you ever educate your clients on the importance of evaluating a building's long-term performance? Key: Empowering the client, is it done?

7) Do the clients assume it's the job of the consultants to evaluate the building? Key: What is expected of a consultant?

8) Is it possible that, because some of the clients are not going to be the end-users of the buildings they commission that they do not care about the building's long-term performance?

9) Have you ever made recommendations that would improve a building only to have them dismissed by the client because of cost/other reasons? (Examples)

Key Question: How do you evaluate the performance of a building?

Tools (#1 Performance Decision Tools #2 BP & economic decision tools.)

1) Hypothetically speaking, what types of decision tools would be useful to you if there were some available? Key: Recognise holes in the market.

2) What specific feature would you want in these tools? Key: Defining the tools needed.

(If not natural, steer towards performance and BP based tools and note reaction.)

3) What are the benefits to your company in using these tools? Why not? Key: Identify obstacles for the implementation phase of our projects.

- If pos. – Do you currently use any tools? Key: ID the ‘good’ software on the market.

Yes – Which ones do you use? Describe their strengths and weaknesses. Key: Use this information to improve our own tools.

No – Is there a reason to not use the tools ex. Are they too difficult to use, do they take too much time to use? Are the results from the current tools worthless? Key: Use this information to improve our own tools.

Key Questions: What influences do economical aspects, such as market conditions and market trends have on the design of a building?

Economical Aspects

1) What are the current market conditions (generally)? Key: Historical background

2) What are the current trends in regards to a) customer demands and b) industry demands? Key: Historical background

3) What do you have to gain by using performance and BP based tools? Key: Identify obstacles for the implementation phase of our projects.

Key Question: Moisture problems are becoming more popular in the media. As you know, it is a part of BP theory. Do you feel comfortable working with BP issues (heat, ventilation and moisture issues)?

Level of Competence

1) Do your co-workers feel comfortable with this?

2) How does the industry in general feel? Nervous?

Comfortable?

3) What is needed to solve this problem?

9 Appendix III – Measured Results

The first nine figures present the results from the isothermal moisture transport measurements. They follow the order of longitudinal, radial and tangential moisture transport for 10, 20 and 30°C. The upper curve shows the RH with t in minutes. The lower curve shows the moisture change $m(t)$ in mg. The tangential isothermal moisture flow sample run at 30 degrees was incomplete. This was not intended. The mistake was that it was assumed that the run had completed successfully since the file size agreed with completed runs. Only later when the data was being analysed, was it discovered that an error had occurred during the run. For the purpose of the analyses, only the good data was used when analysing this run.

The remaining five figures present measured data from the nonisothermal moisture transport method presented in Chapter 4. The figures are for a longitudinal moisture transport with a 10°C (20°C air to 30°C heating pad) temperature gradient through the material. Each figure shows a step change in RH in the air the sample is exposed to at 20°C: 0-15%, 15-33%, 33-55%, 55-75%, and 75-95%.

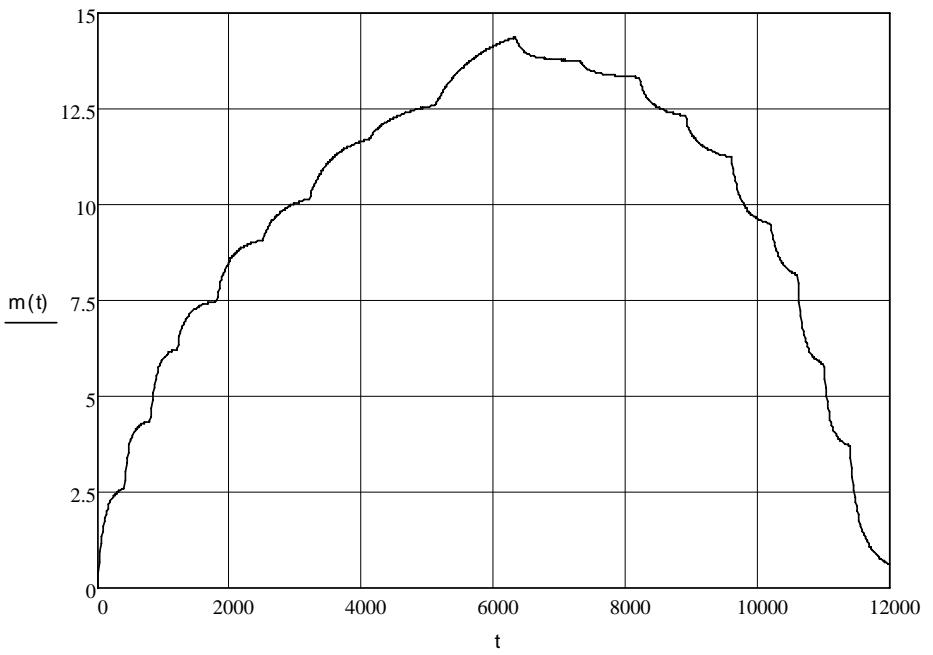
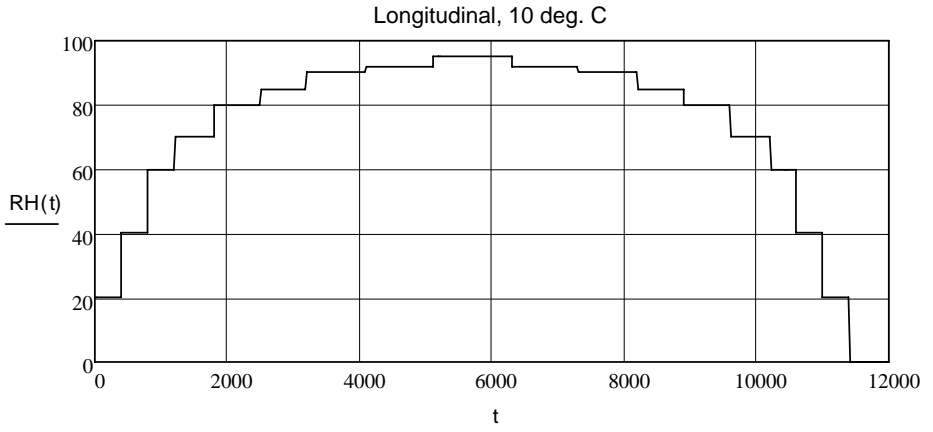

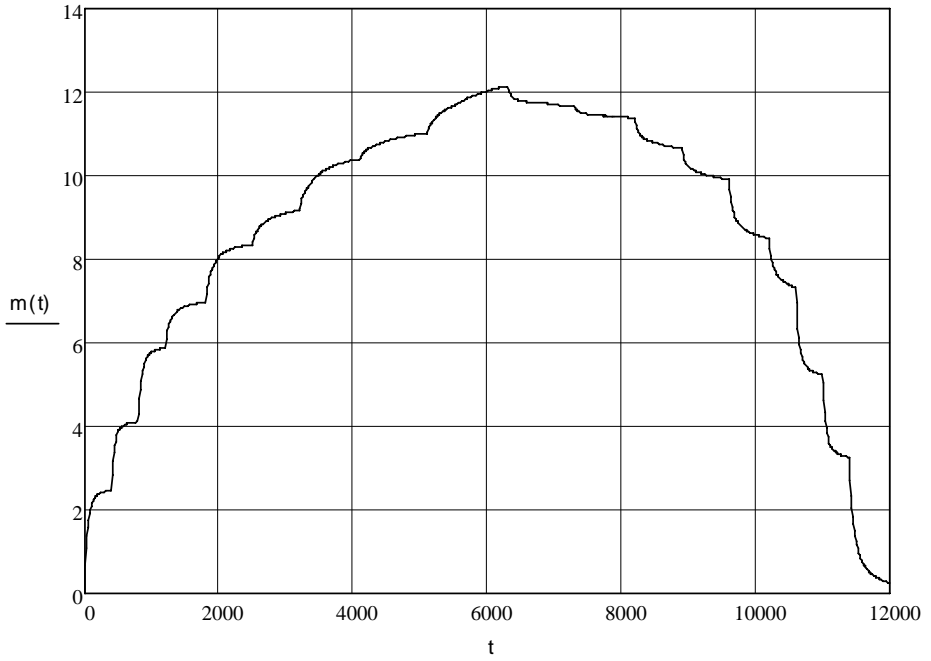
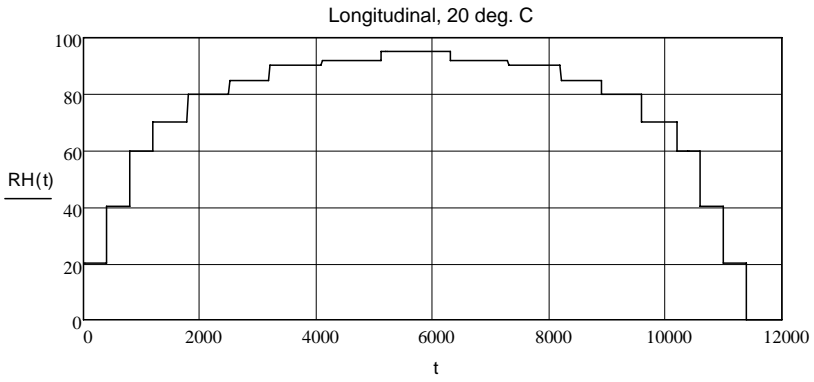

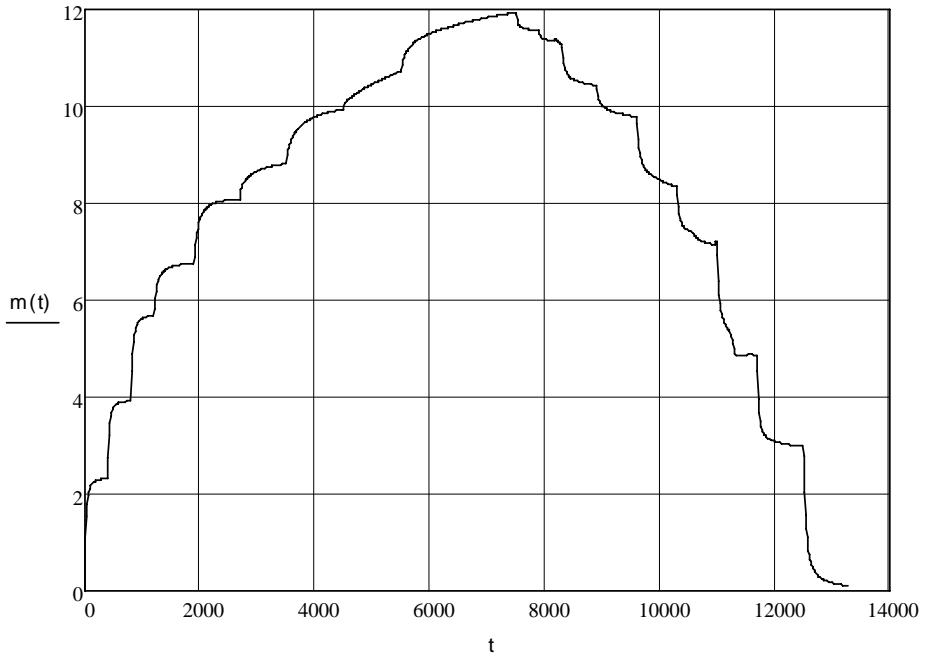
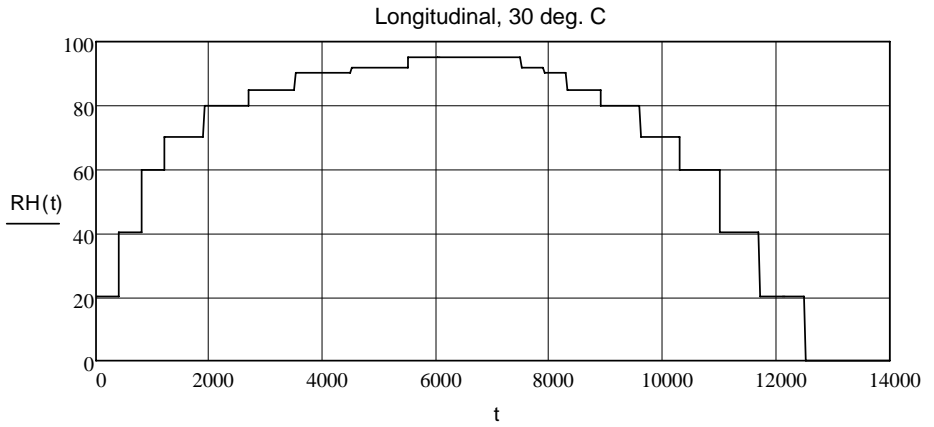

Tangential, 10 deg. C

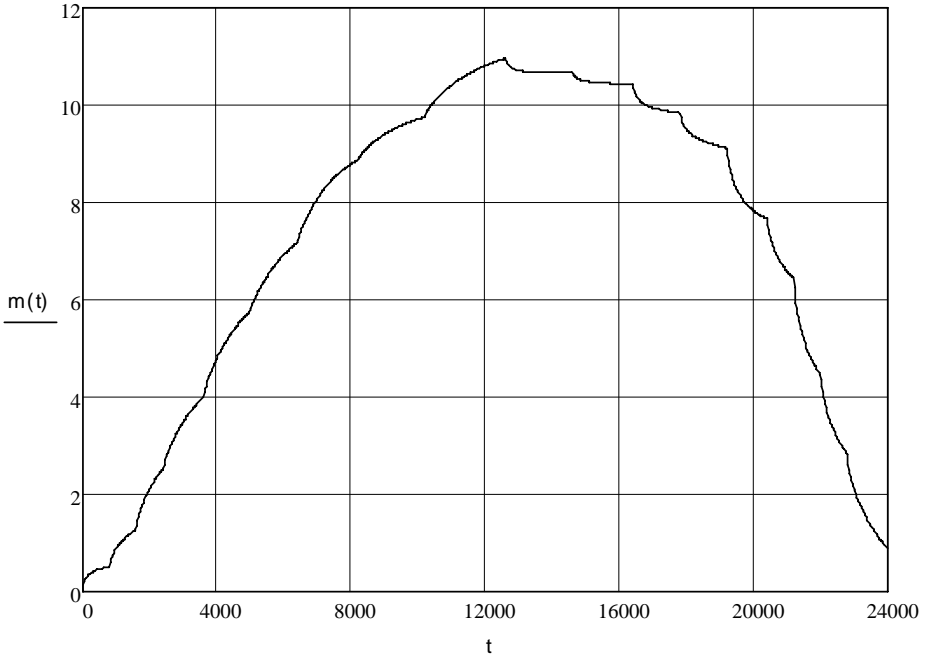
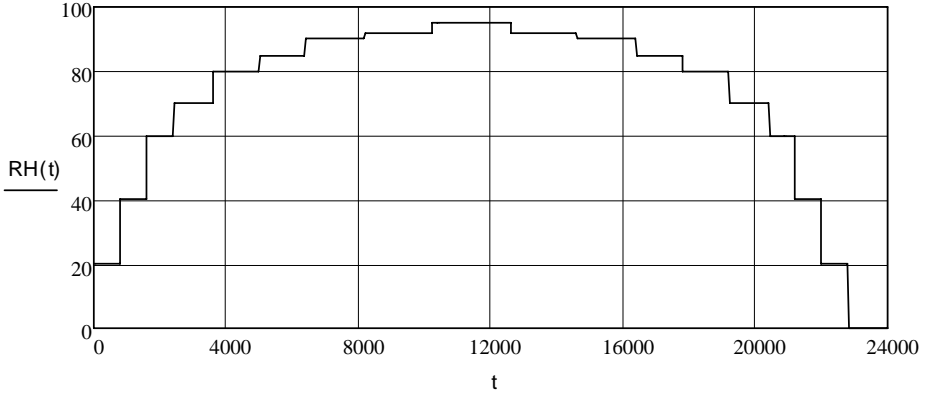

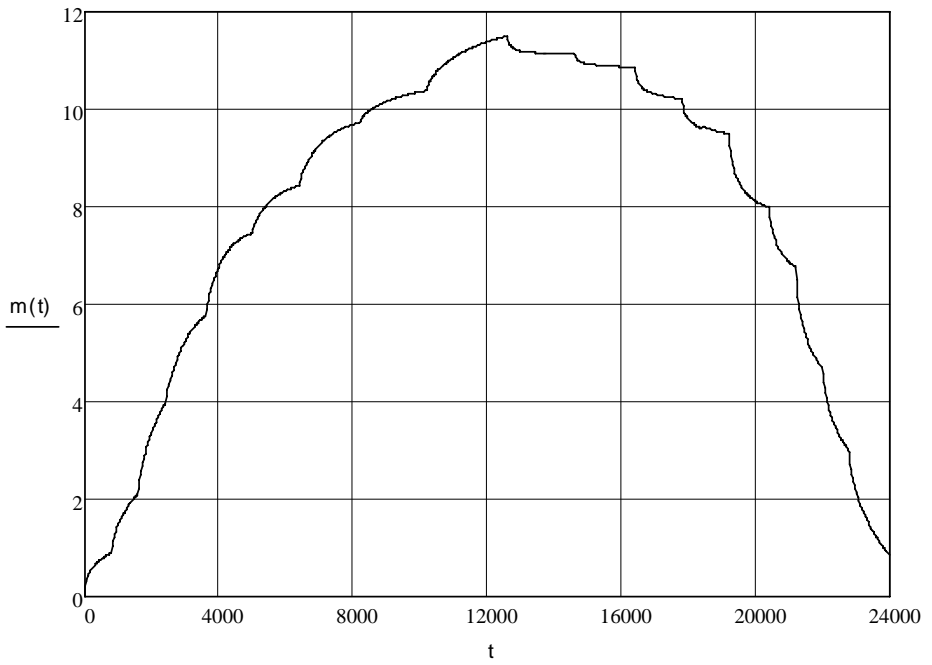
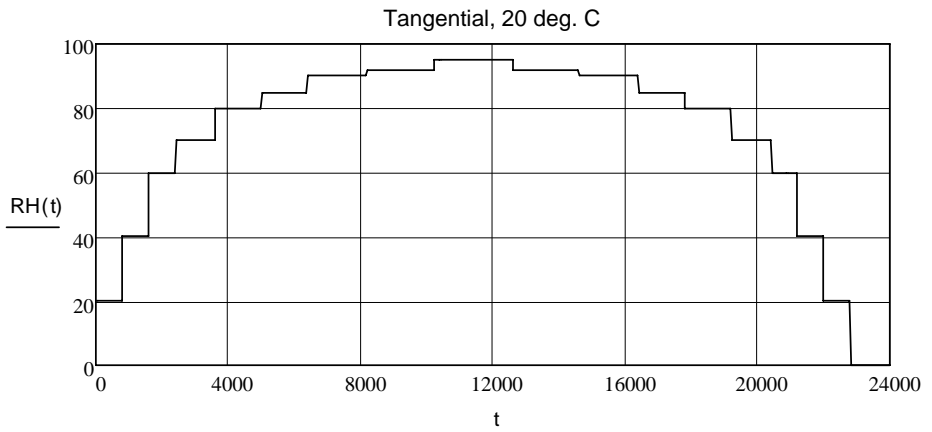

Tangential, 30 deg. C

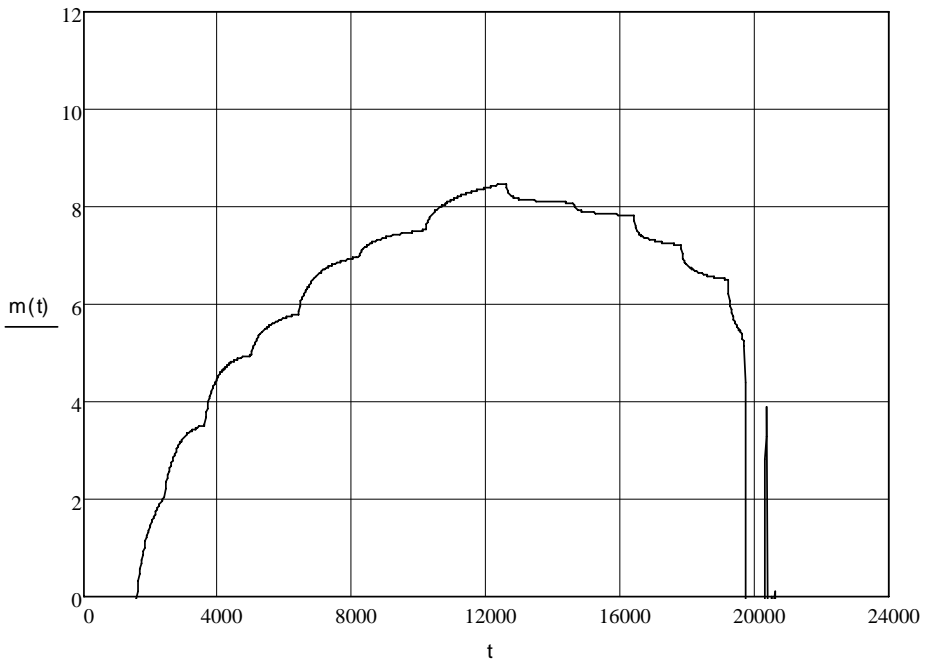
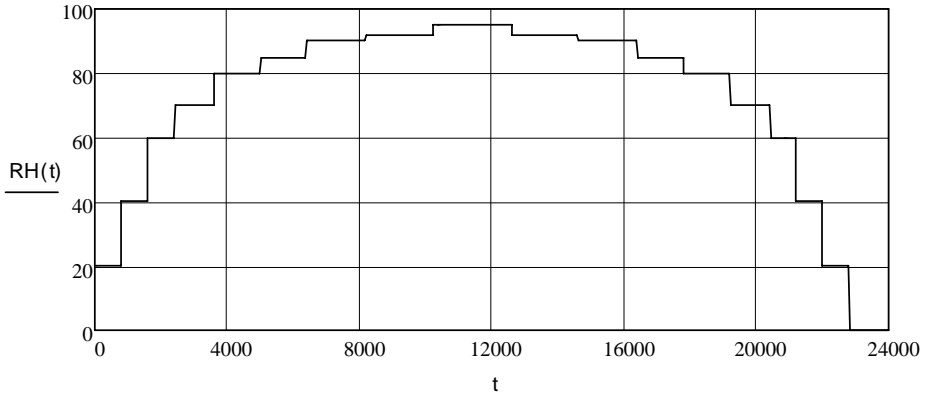

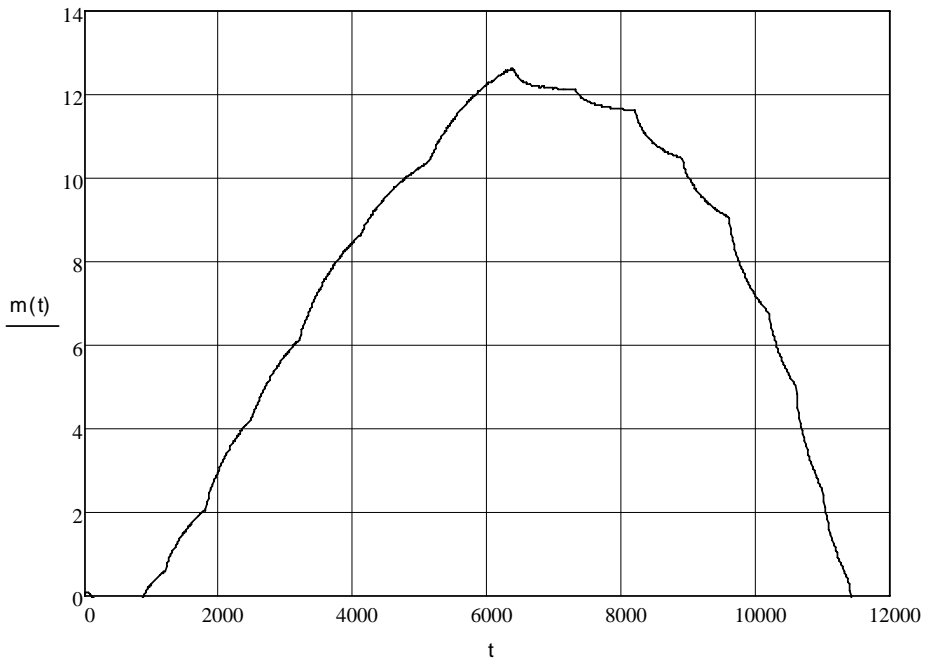
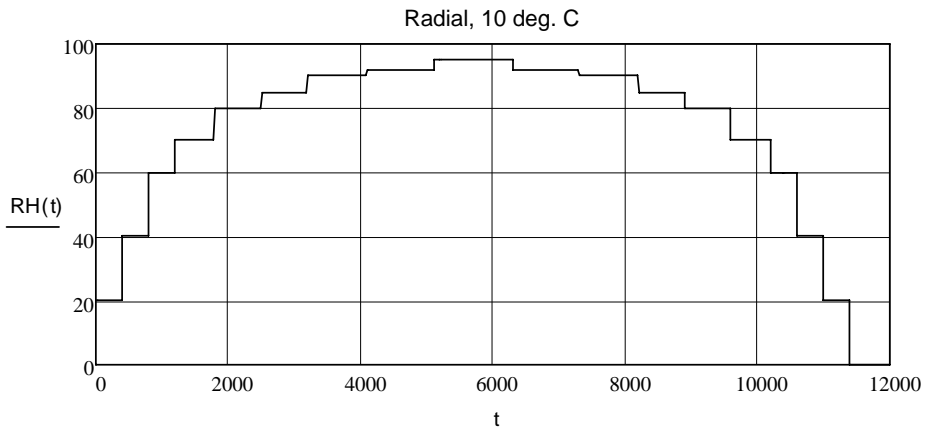

Radial, 20 deg. C

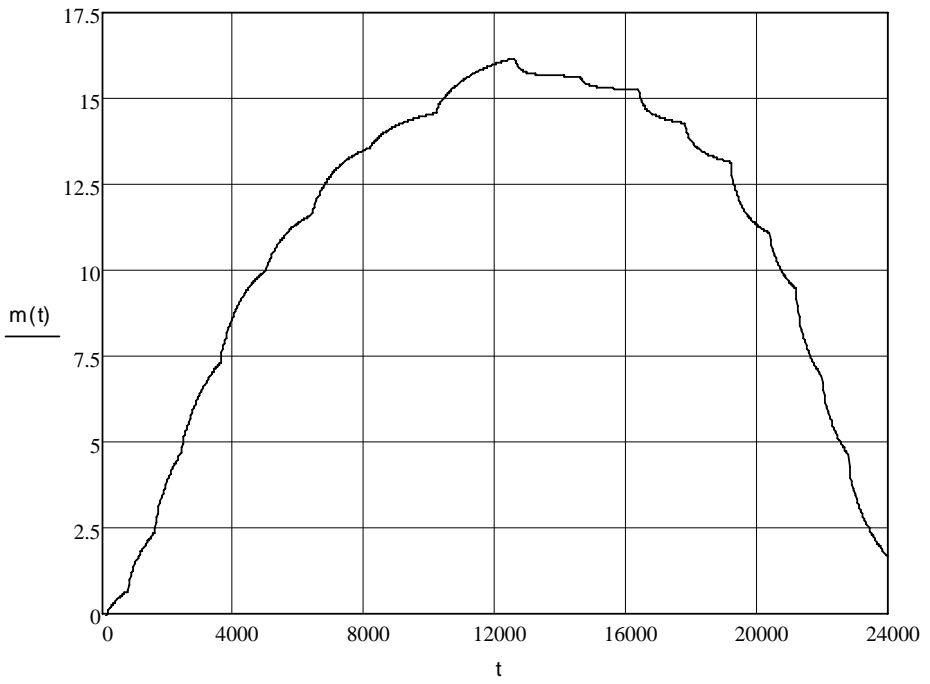
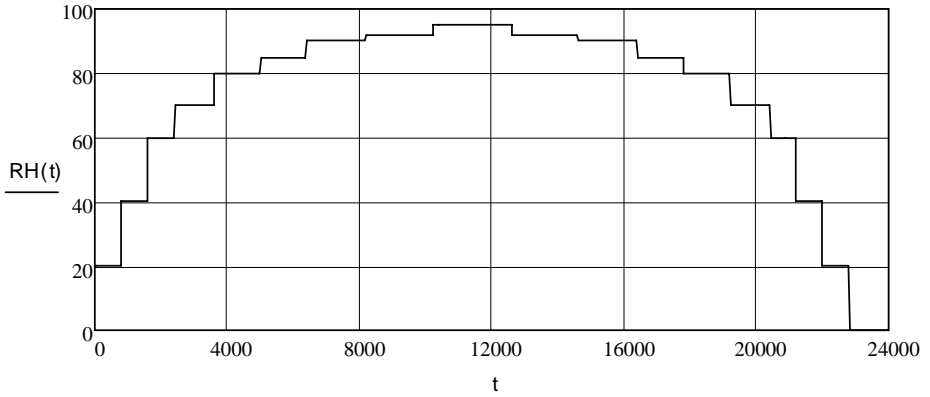

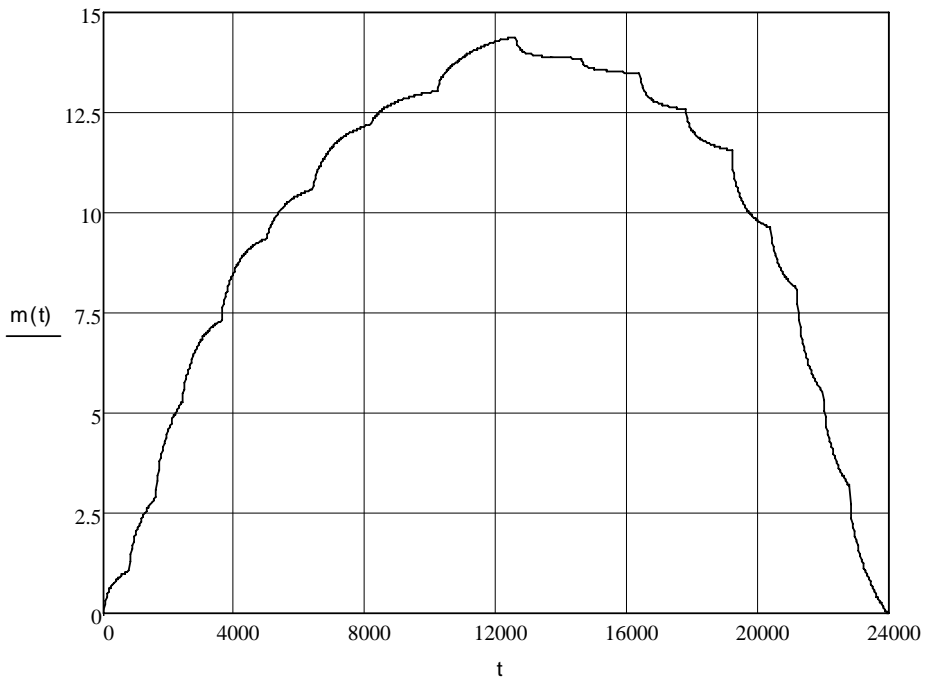
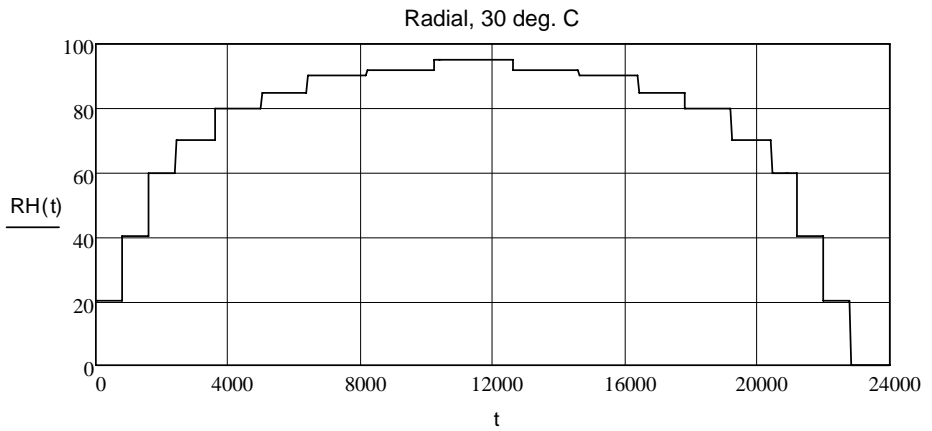

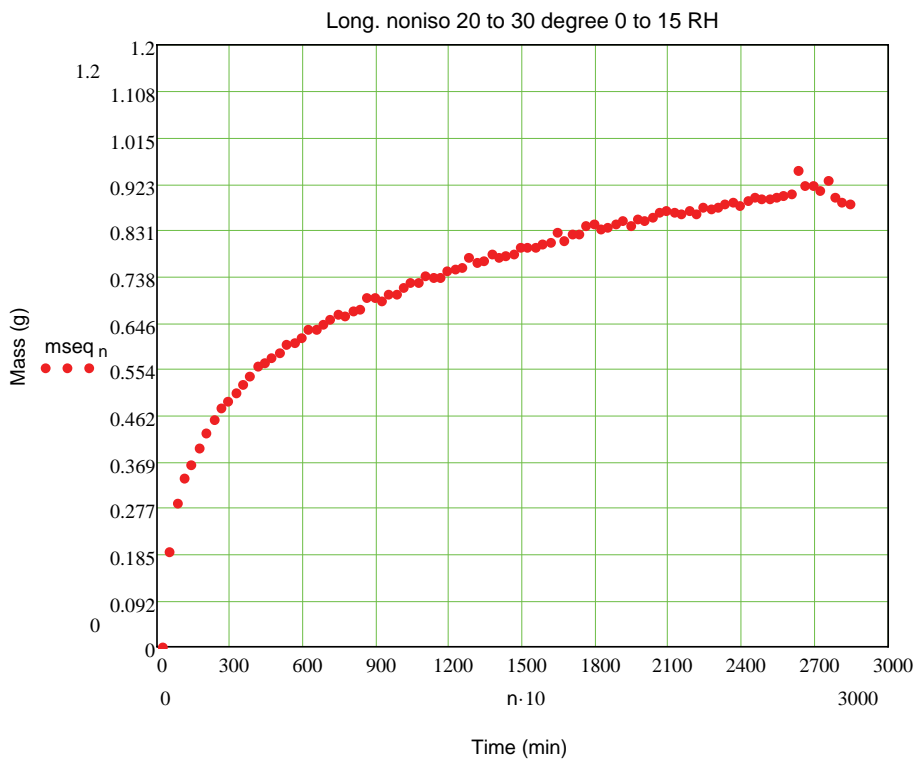

Long. noniso 20 to 30 degree 15 to 33 RH

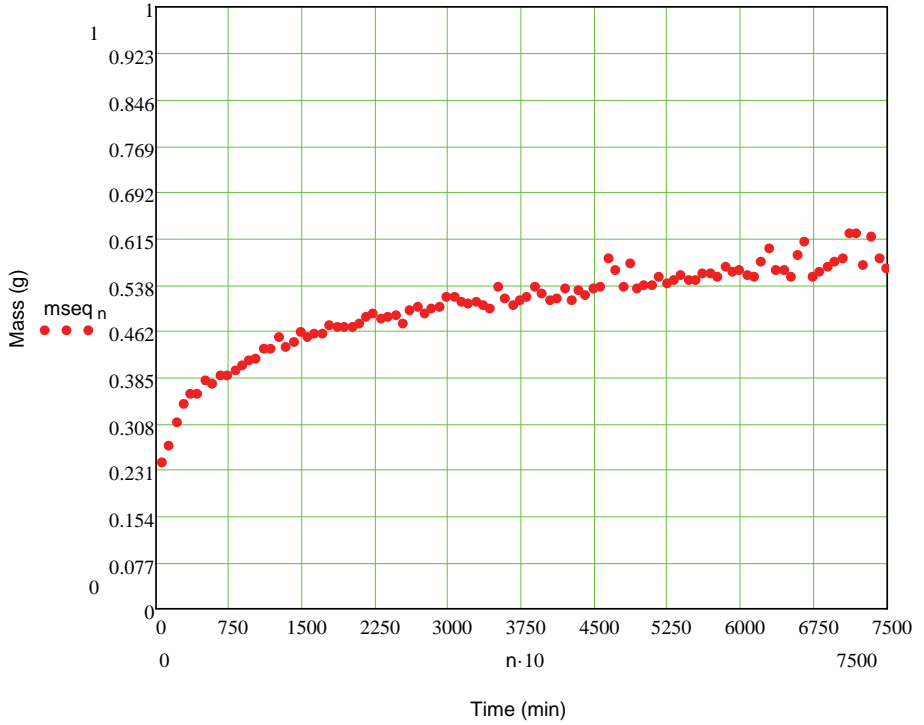

Long. noniso 20 to 30 degree 33 to 55 RH

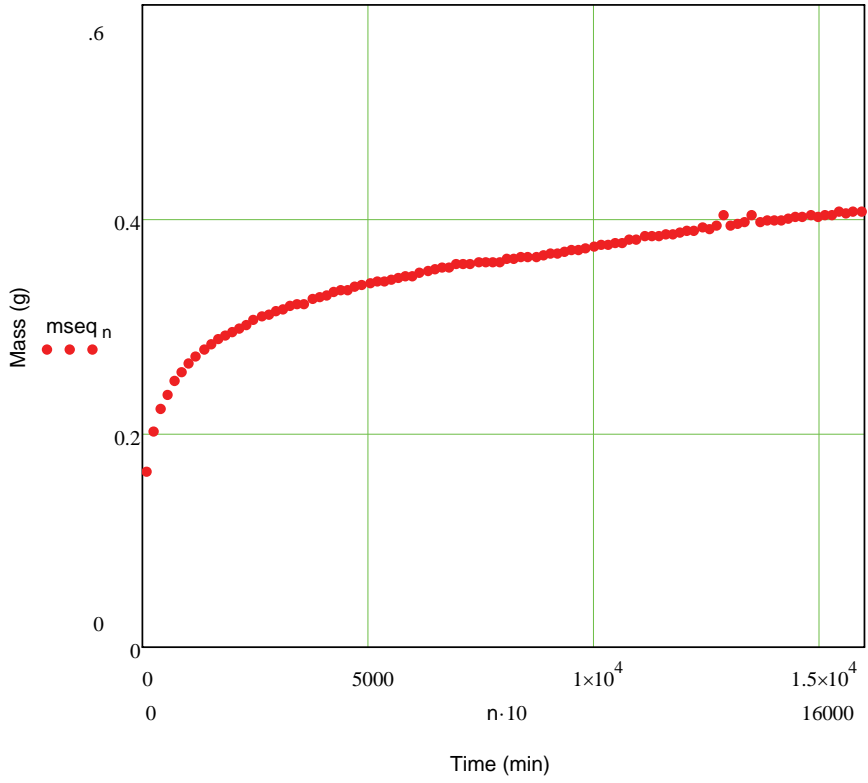

Long. noniso 20 to 30 degree 55 to 75 RH

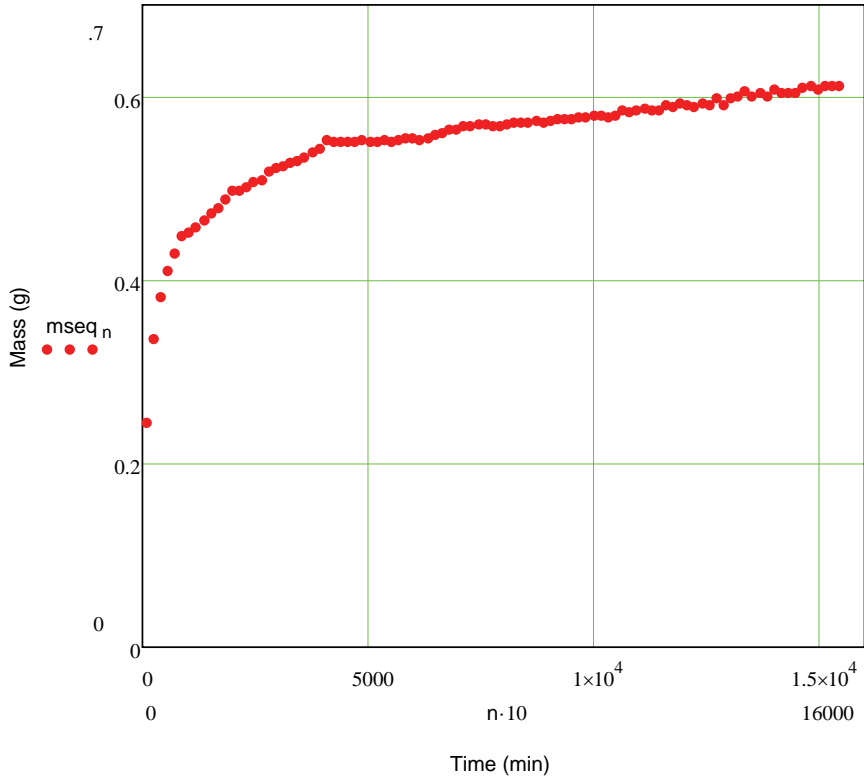

Long. noniso 20 to 30 degree 75 to95 RH

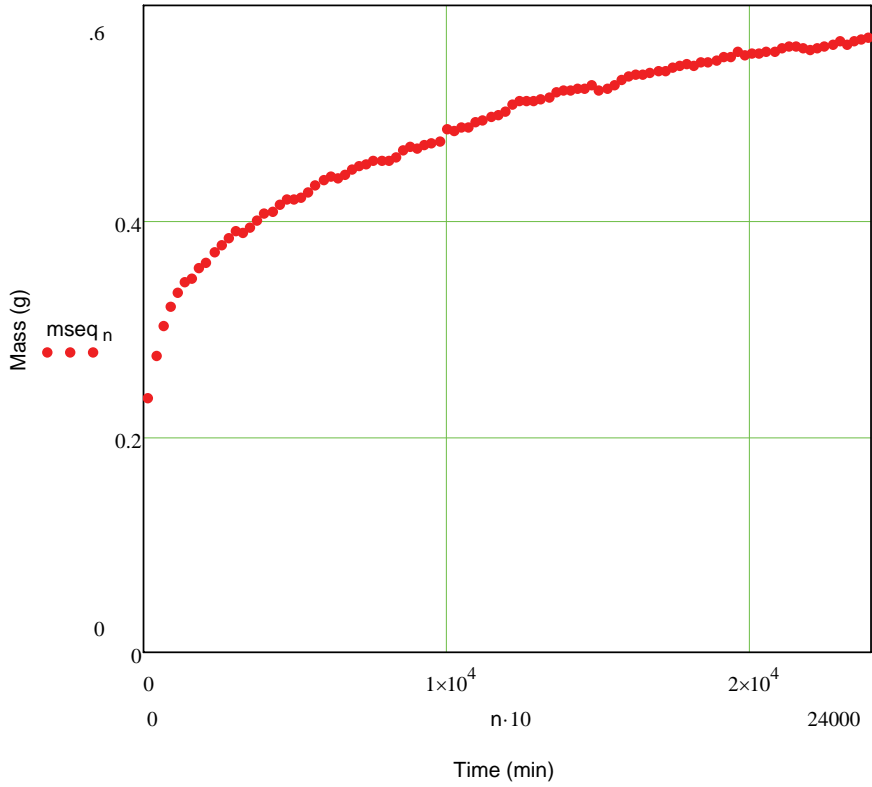

Dissertations from Building Physics, Lund University, Sweden

Bankvall C G	Natural Convective Heat Transfer in Insulated Structures. Report 38. Heat Transfer in Insulation and Insulated Structure. Report 39.	1972
Sandberg P-I	Moisture Balance in Building Elements Exposed to Natural Climatic Conditions. Report 43. (in Swedish)	1973
Bomberg M	Moisture Flow through Porous Building Materials. Report	1974
Samuelsson I	Moisture Transfer in Steel Deck. Report 67. (in Swedish)	1976
Andersson A-C	Internal Additional Insulation. Thermal Bridges, Moisture problems Movements and Durability. TVBH-1001. (in Swedish)	1979
Kronvall J	Air Flows in Building Components. TVBH-1002.	1980
Jóhannesson G	Active Heat Capacity. Models and Parameters for the Thermal Performance of Buildings. TVBH-1003.	1981
Hagetoft C-E	Heat Loss to the Ground from a Building. Slab on the Ground and Cellar. TVBH-1004.	1988
Harderup L-E	Concrete Slab on the Ground and Moisture Control. Verification of some Methods to Improve the Moisture Conditions in the Foundation. TVBH-1005.	1991
Bornehag C-G	Mönsteranalys av inomhusluft – Undersökning av luftkvalitet i sjuka hus med flytspackelproblem. BFR Report no R23:1994. Swedish Council of Building Research. Stockholm. (in Swedish)	1994
Blomberg T	Heat Conduction in Two and Three Dimensions. Computer Modelling of Building Physics Applications. TVBH-1008.	1996
Roots P	Heat Transfer through a Well Insulated External Wooden Frame Wall. TVBH-1009.	1997
Arfvidsson J	Moisture Transport in Porous Media. Modelling Based on Kirchhoff Potentials. TVBH-1010.	1998
Harderup E	Methods to select corrections for moisture calculations at variable external climatic data. TVBH-1011 (in Swedish)	1998

Adalberth K	Energy Use and Environmental Impact of New Residential Buildings. TVBH-1012.	2000
Engdahl F	Air – for Health and Comfort. An Analysis of HVAC Systems' Performance in Theory and Practice. TVBH-1013	2002
Johansson D	Modelling Life Cycle Cost for Indoor Climate Systems. TVBH-1014	2005
Hägerhed Engman L	Indoor environmental factors and their association with asthma and allergy among Swedish pre-school children. TVBH-1015	2006
Svennberg K	Moisture Buffering in the Indoor Environment. TVBH-1016	2006
Burke S	Building Physics Tools: Needs, Use and the Lack of Use in the Building Process. Modelling Non-Isothermal Moisture Flow and Frost Penetration. TVBH - 1017	2009